

Life Is On

Schneider
Electric



 Price List

Final Distribution, Wiring Devices and Lighting Control Products

With effect from February 03rd, 2025

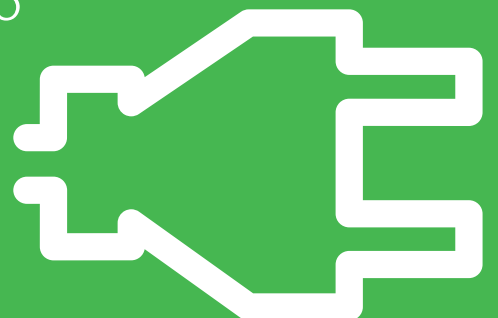

se.com/in

Acti 9 Distribution System	4
Miniature Circuit Breakers (MCBs).....	8
Residual Current Devices.....	11
Auxiliaries and Accessories for MCBs / RCDs	14
Surge Protection Devices.....	16
Control and Command Products.....	18
ComReady Control and Command Products.....	20
Isobar Distribution System	21
Acti 9 Isobar Pan Assembly	23
Acti 9 Distribution Boards.....	24
Acti 9 Modular Distribution Boards - Metallic.....	28
Timers & Time Switches	35
Kaedra Enclosures	37
Weather Proof	37
PratiKa.....	39
Plugs and Sockets - IP44 / IP67	39
Electra	43
Metal Clad Plugs & Sockets	43
56 Series	44
Plugs and Sockets - IP56 / IP66	44
Wiring Devices	47
LIVIA - Switch to the extra-ordinary.....	48
Miluz Lara	50
Clipsal X - As Stylish As Your World	54
Opale - Switches with Satin Finish	57
Unica Pure - Irresistibly Beautiful	59
ZENcelo India - The Revolutionary Full-Flat Switch	67
AvatarOn - It's also a Switch.....	71
Kavacha - Weather Protected Series.....	78
Metal Boxes	79
Wiser.....	80
Surface and Flush Mount Occupancy Sensors.....	81
Wall Mount Sensors.....	82
Hotel - ELV Dual Motion Sensor	82

Acti 9 | Advanced Communication Technology that Inspires

> Protection devices

- Miniature circuit breakers
- Residual current circuit breakers
- Vigi™ residual current devices
- Surge Protection Devices

> Protection monitoring and supervision

- Indication and tripping auxiliaries
- Remote control auxiliaries
- Automatic reclosure auxiliaries



Innovative
Protection monitoring Total control and
Metering @ DB level



Efficient
Manage loads, reduce operating and project
costs, and accurately plan maintenance

> Control and monitoring

- Contactors
- Impulse relays
- Integrated control circuit breakers
- Light indicators
- Push-buttons and selector switches
- Kilowatt hour meters
- Communicating architecture

> Installation system

- IP20B terminals
- Splitter blocks
- Full range of mounting and wiring accessories



Reliable

Dual certifications for one product, 100 percent MCB and RCD coordination, easy ordering and design, error free fast connections

Acti 9 | Advanced Communication Technology that Inspires.....

> Innovative

- Centralized control system including energy metering
- Large and variable data reading and computing through universal Modbus protocol

> Efficient

- One-click, prefabricated wiring for comprehensive communication between your distribution board or panel and any facility management system

> Reliable

- Error proof connection leading to reduction in downtime
- EMC tested for immunity, radiated and conducted safety

NEW

Email Notification upon Event (Devices Status Change, Alarm threshold reached etc.)

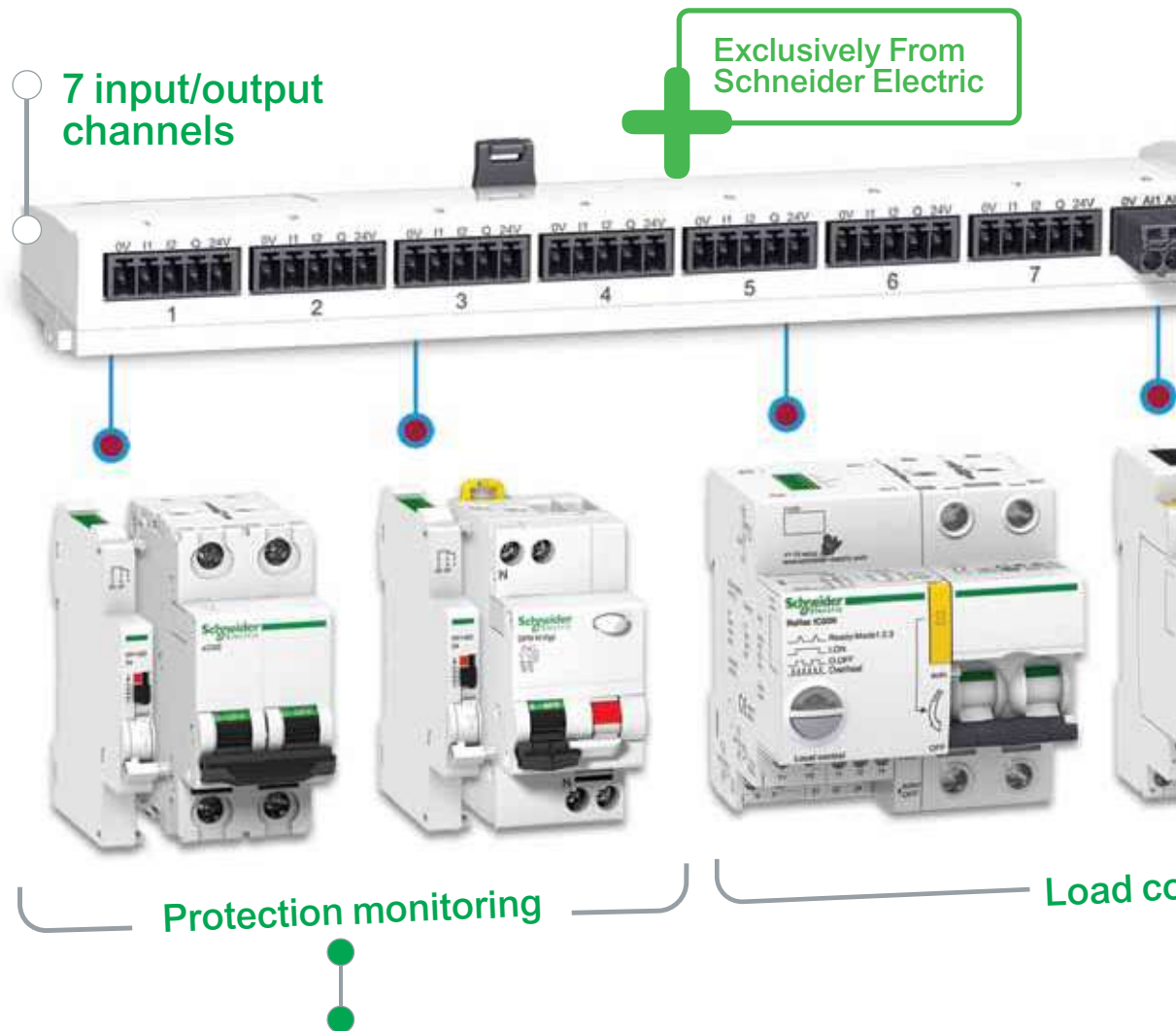

- > Status Monitoring - ON / OFF / TRIP
- > Trip Alarm Indication
- > Load Monitoring - No. of tripping cycles, Running Hours

- > Switching Action - ON / OFF
- > Monitoring - No. of Switching cycles, Running hours



Meets the challenge of all your applications

Detailed load control, reduced downtime and accurately planned maintenance

Ready to connect to any facility management solution

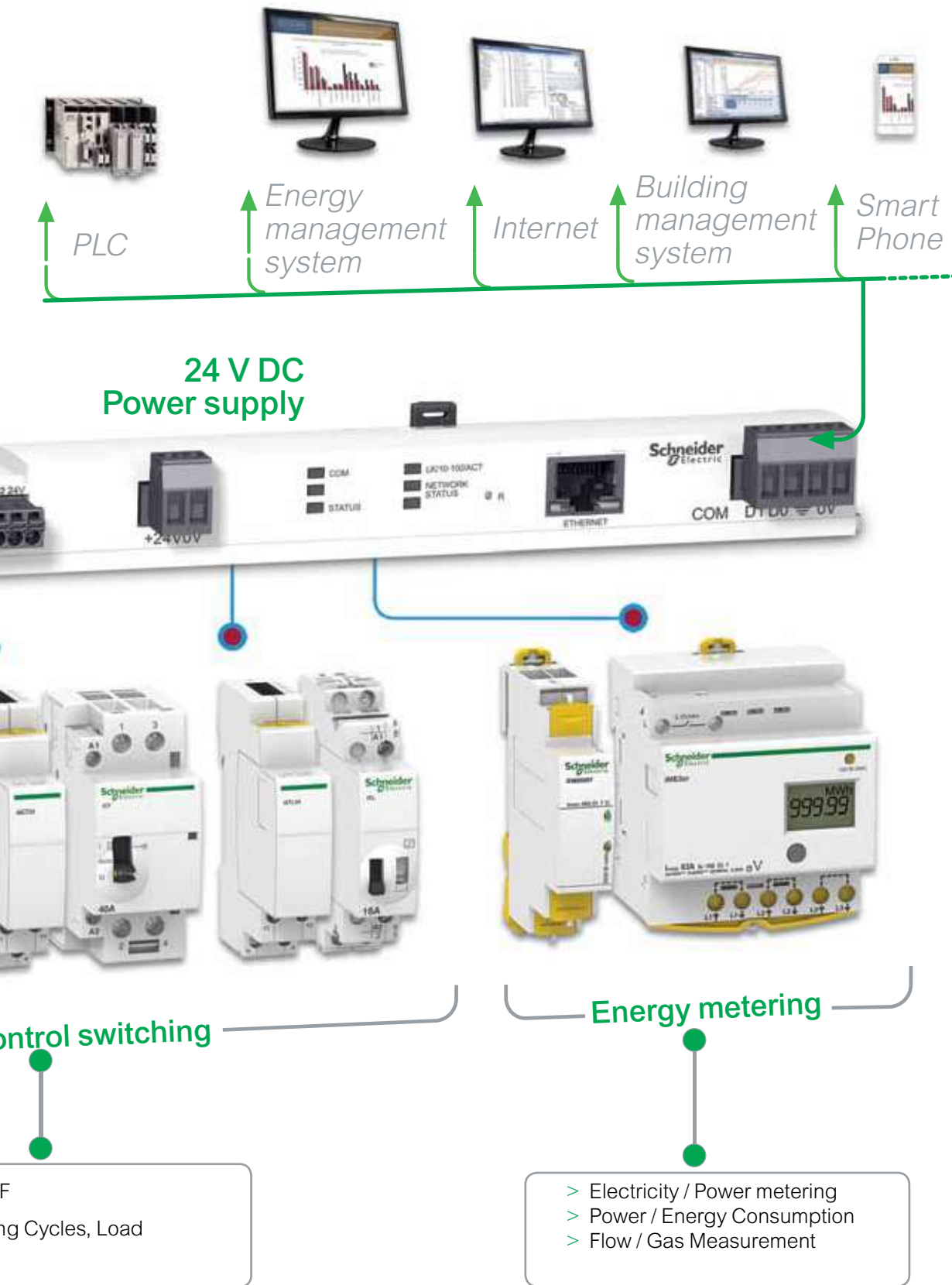

Green Premium Products

100% Recyclable and Recoverable
REACH, RoHS, PEP, EOL compliant

AC Miniature Circuit Breakers - xC60 - IS/IEC 60898-1



Green Premium

- Breaking Capacity as per IEC 60898 and IS/IEC 60898-1, Icn = 10kA
- Can be used for DC application upto 60V per pole
- Higher Installation Life: Energy Limitation Class 3, Fast Closure Mechanism
- Ease, Speed and Flexibility of installation - Biconnect, Line-Load Reversible
- Field-fittable auxiliaries for advance protection and monitoring
- Positive Contact Indication for assurance of disconnection

[In] Rated Current (A)	1 Pole Reference	Unit MRP [₹]	2 Pole Reference	Unit MRP [₹]	3 Pole Reference	Unit MRP [₹]	4 Pole Reference	Unit MRP [₹]
Module Width**	1 mod		2 mod		3 mod		4 mod	
MOQ	12 Nos.		6 Nos.		4 Nos.		3 Nos.	
B curve								
6	A9N1P06BGN <input checked="" type="checkbox"/>	474	A9N2P06BGN <input checked="" type="checkbox"/>	1430	A9N3P06BGN <input checked="" type="checkbox"/>	2373	-	-
10	A9N1P10BGN <input checked="" type="checkbox"/>	474	A9N2P10BGN <input checked="" type="checkbox"/>	1430	A9N3P10BGN <input checked="" type="checkbox"/>	2373	-	-
16	A9N1P16BGN <input checked="" type="checkbox"/>	474	A9N2P16BGN <input checked="" type="checkbox"/>	1430	A9N3P16BGN <input checked="" type="checkbox"/>	2373	-	-
20	A9N1P20BGN <input checked="" type="checkbox"/>	474	A9N2P20BGN <input checked="" type="checkbox"/>	1430	-	-	-	-
25	A9N1P25BGN <input checked="" type="checkbox"/>	474	-	-	A9N3P25BGN <input checked="" type="checkbox"/>	2373	-	-
32	A9N1P32BGN <input checked="" type="checkbox"/>	474	-	-	A9N3P32BGN <input checked="" type="checkbox"/>	2373	A9N4P32BGN	3197
40	A9N1P40BGN <input checked="" type="checkbox"/>	1028	-	-	-	-	A9N4P40BGN	4602
63	A9N1P63BGN <input checked="" type="checkbox"/>	1042	-	-	A9N3P63BGN <input checked="" type="checkbox"/>	3644	A9N4P63BGN	4644
C curve								
1	A9N1P01CGN <input checked="" type="checkbox"/>	726	A9N2P01CGN <input checked="" type="checkbox"/>	1980	A9N3P01CGN <input checked="" type="checkbox"/>	3125	A9N4P01CGN <input checked="" type="checkbox"/>	3933
2	A9N1P02CGN <input checked="" type="checkbox"/>	726	-	-	A9N3P02CGN <input checked="" type="checkbox"/>	3125	A9N4P02CGN <input checked="" type="checkbox"/>	3933
3	A9N1P03CGN <input checked="" type="checkbox"/>	726	A9N2P03CGN <input checked="" type="checkbox"/>	1980	A9N3P03CGN <input checked="" type="checkbox"/>	3125	-	-
4	A9N1P04CGN <input checked="" type="checkbox"/>	726	A9N2P04CGN <input checked="" type="checkbox"/>	1980	A9N3P04CGN <input checked="" type="checkbox"/>	3125	A9N4P04CGN <input checked="" type="checkbox"/>	3933
6	A9N1P06CGN <input checked="" type="checkbox"/>	430	A9N2P06CGN <input checked="" type="checkbox"/>	1430	A9N3P06CGN <input checked="" type="checkbox"/>	2373	A9N4P06CGN <input checked="" type="checkbox"/>	3197
10	A9N1P10CGN <input checked="" type="checkbox"/>	430	A9N2P10CGN <input checked="" type="checkbox"/>	1430	A9N3P10CGN <input checked="" type="checkbox"/>	2373	A9N4P10CGN <input checked="" type="checkbox"/>	3197
16	A9N1P16CGN <input checked="" type="checkbox"/>	430	A9N2P16CGN <input checked="" type="checkbox"/>	1430	A9N3P16CGN <input checked="" type="checkbox"/>	2373	A9N4P16CGN <input checked="" type="checkbox"/>	3197
20	A9N1P20CGN <input checked="" type="checkbox"/>	430	A9N2P20CGN <input checked="" type="checkbox"/>	1430	A9N3P20CGN <input checked="" type="checkbox"/>	2373	A9N4P20CGN <input checked="" type="checkbox"/>	3197
25	A9N1P25CGN <input checked="" type="checkbox"/>	430	A9N2P25CGN <input checked="" type="checkbox"/>	1430	A9N3P25CGN <input checked="" type="checkbox"/>	2373	A9N4P25CGN <input checked="" type="checkbox"/>	3197
32	A9N1P32CGN <input checked="" type="checkbox"/>	430	A9N2P32CGN <input checked="" type="checkbox"/>	1430	A9N3P32CGN <input checked="" type="checkbox"/>	2373	A9N4P32CGN <input checked="" type="checkbox"/>	3197
40	A9N1P40CGN <input checked="" type="checkbox"/>	1028	A9N2P40CGN <input checked="" type="checkbox"/>	2302	A9N3P40CGN <input checked="" type="checkbox"/>	3613	A9N4P40CGN <input checked="" type="checkbox"/>	4510
50	A9N1P50CGN	1028	A9N2P50CGN	2302	A9N3P50CGN	3613	A9N4P50CGN	4644
63	A9N1P63CGN <input checked="" type="checkbox"/>	1042	A9N2P63CGN <input checked="" type="checkbox"/>	2322	A9N3P63CGN <input checked="" type="checkbox"/>	3733	A9N4P63CGN <input checked="" type="checkbox"/>	4837
D curve								
2	A9N1P02DGN <input checked="" type="checkbox"/>	733	A9N2P02DGN <input checked="" type="checkbox"/>	2001	-	-	-	-
3	A9N1P03DGN <input checked="" type="checkbox"/>	733	-	-	A9N3P03DGN <input checked="" type="checkbox"/>	3173	-	-
4	A9N1P04DGN <input checked="" type="checkbox"/>	733	A9N2P04DGN <input checked="" type="checkbox"/>	2001	A9N3P04DGN <input checked="" type="checkbox"/>	3173	-	-
6	A9N1P06DGN <input checked="" type="checkbox"/>	618	A9N2P06DGN <input checked="" type="checkbox"/>	1499	A9N3P06DGN <input checked="" type="checkbox"/>	2499	-	-
10	A9N1P10DGN <input checked="" type="checkbox"/>	618	A9N2P10DGN <input checked="" type="checkbox"/>	1499	A9N3P10DGN <input checked="" type="checkbox"/>	2499	-	-
16	A9N1P16DGN <input checked="" type="checkbox"/>	618	A9N2P16DGN <input checked="" type="checkbox"/>	1499	A9N3P16DGN <input checked="" type="checkbox"/>	2499	A9N4P16DGN <input checked="" type="checkbox"/>	3315
20	A9N1P20DGN <input checked="" type="checkbox"/>	618	A9N2P20DGN <input checked="" type="checkbox"/>	1499	A9N3P20DGN <input checked="" type="checkbox"/>	2499	A9N4P20DGN <input checked="" type="checkbox"/>	3315
25	A9N1P25DGN <input checked="" type="checkbox"/>	618	A9N2P25DGN <input checked="" type="checkbox"/>	1499	A9N3P25DGN <input checked="" type="checkbox"/>	2499	A9N4P25DGN <input checked="" type="checkbox"/>	3315
32	A9N1P32DGN <input checked="" type="checkbox"/>	618	A9N2P32DGN <input checked="" type="checkbox"/>	1499	A9N3P32DGN <input checked="" type="checkbox"/>	2499	A9N4P32DGN <input checked="" type="checkbox"/>	3315
40	A9N1P40DGN <input checked="" type="checkbox"/>	1110	A9N2P40DGN <input checked="" type="checkbox"/>	2433	A9N3P40DGN <input checked="" type="checkbox"/>	3828	A9N4P40DGN <input checked="" type="checkbox"/>	4800
50	-	-	-	-	A9N3P50DGN	3828	-	-
63	A9N1P63DGN <input checked="" type="checkbox"/>	1124	A9N2P63DGN <input checked="" type="checkbox"/>	2462	A9N3P63DGN <input checked="" type="checkbox"/>	3862	A9N4P63DGN <input checked="" type="checkbox"/>	4850

Please contact Customer Care Center for Stockable and Non stockable status of references.

NORMAL STOCK ITEMS

W.E.F. February 03rd, 2025

AC Miniature Circuit Breakers - XC60 - IEC - 60947-2



Green Premium

- Breaking Capacity as per IEC 60947-2, Icn = 10kA
- Can be used for DC application upto 60V per pole
- Higher system performance with optimized cost: Cascading*
- Increased System Continuity: Discrimination*
- Higher Installation Life: Energy Limitation Class 3, Fast Closure Mechanism
- Ease, Speed and Flexibility of installation - Biconnect, Line-Load Reversible
- Field-fittable auxiliaries for advance protection and monitoring
- Positive Contact Indication for assurance of disconnection

[In] Rated Current (A)	1 Pole Reference	Unit MRP [₹]	2 Pole Reference	Unit MRP [₹]	3 Pole Reference	Unit MRP [₹]	4 Pole Reference	Unit MRP [₹]
Module Width**	1 mod		2 mod		3 mod		4 mod	
MOQ	12 Nos.		6 Nos.		4 Nos.		3 Nos.	
B curve								
6	A9N1P06BIN <input checked="" type="checkbox"/>	488	A9N2P06BIN <input checked="" type="checkbox"/>	1473	A9N3P06BIN <input checked="" type="checkbox"/>	2444	-	-
10	A9N1P10BIN <input checked="" type="checkbox"/>	488	A9N2P10BIN <input checked="" type="checkbox"/>	1473	A9N3P10BIN <input checked="" type="checkbox"/>	2444	-	-
16	A9N1P16BIN <input checked="" type="checkbox"/>	488	A9N2P16BIN <input checked="" type="checkbox"/>	1473	A9N3P16BIN <input checked="" type="checkbox"/>	2444	-	-
20	A9N1P20BIN <input checked="" type="checkbox"/>	488	A9N2P20BIN <input checked="" type="checkbox"/>	1473	-	-	-	-
25	A9N1P25BIN <input checked="" type="checkbox"/>	488	-	-	A9N3P25BIN <input checked="" type="checkbox"/>	2444	-	-
32	A9N1P32BIN <input checked="" type="checkbox"/>	488	-	-	A9N3P32BIN <input checked="" type="checkbox"/>	2444	A9N4P32BIN <input checked="" type="checkbox"/>	3293
40	A9N1P40BIN <input checked="" type="checkbox"/>	1059	-	-	-	-	A9N4P40BIN <input checked="" type="checkbox"/>	4740
63	A9N1P63BIN <input checked="" type="checkbox"/>	1074	-	-	A9N3P63BIN <input checked="" type="checkbox"/>	3754	A9N4P63BIN <input checked="" type="checkbox"/>	4784
C curve								
1	A9N1P01CIN <input checked="" type="checkbox"/>	748	A9N2P01CIN <input checked="" type="checkbox"/>	2040	A9N3P01CIN <input checked="" type="checkbox"/>	3219	A9N4P01CIN <input checked="" type="checkbox"/>	4051
2	A9N1P02CIN <input checked="" type="checkbox"/>	748	A9N2P02CIN <input checked="" type="checkbox"/>	2040	A9N3P02CIN <input checked="" type="checkbox"/>	3219	A9N4P02CIN <input checked="" type="checkbox"/>	4051
3	A9N1P03CIN <input checked="" type="checkbox"/>	748	A9N2P03CIN <input checked="" type="checkbox"/>	2040	A9N3P03CIN <input checked="" type="checkbox"/>	3219	-	-
4	A9N1P04CIN <input checked="" type="checkbox"/>	748	A9N2P04CIN <input checked="" type="checkbox"/>	2040	A9N3P04CIN <input checked="" type="checkbox"/>	3219	A9N4P04CIN <input checked="" type="checkbox"/>	4051
6	A9N1P06CIN <input checked="" type="checkbox"/>	443	A9N2P06CIN <input checked="" type="checkbox"/>	1473	A9N3P06CIN <input checked="" type="checkbox"/>	2444	A9N4P06CIN <input checked="" type="checkbox"/>	3293
10	A9N1P10CIN <input checked="" type="checkbox"/>	443	A9N2P10CIN <input checked="" type="checkbox"/>	1473	A9N3P10CIN <input checked="" type="checkbox"/>	2444	A9N4P10CIN <input checked="" type="checkbox"/>	3293
16	A9N1P16CIN <input checked="" type="checkbox"/>	443	A9N2P16CIN <input checked="" type="checkbox"/>	1473	A9N3P16CIN <input checked="" type="checkbox"/>	2444	A9N4P16CIN <input checked="" type="checkbox"/>	3293
20	A9N1P20CIN <input checked="" type="checkbox"/>	443	A9N2P20CIN <input checked="" type="checkbox"/>	1473	A9N3P20CIN <input checked="" type="checkbox"/>	2444	A9N4P20CIN <input checked="" type="checkbox"/>	3293
25	A9N1P25CIN <input checked="" type="checkbox"/>	443	A9N2P25CIN <input checked="" type="checkbox"/>	1473	A9N3P25CIN <input checked="" type="checkbox"/>	2444	A9N4P25CIN <input checked="" type="checkbox"/>	3293
32	A9N1P32CIN <input checked="" type="checkbox"/>	443	A9N2P32CIN <input checked="" type="checkbox"/>	1473	A9N3P32CIN <input checked="" type="checkbox"/>	2444	A9N4P32CIN <input checked="" type="checkbox"/>	3293
40	A9N1P40CIN <input checked="" type="checkbox"/>	1059	A9N2P40CIN <input checked="" type="checkbox"/>	2372	A9N3P40CIN <input checked="" type="checkbox"/>	3722	A9N4P40CIN <input checked="" type="checkbox"/>	4646
50	A9N1P50CIN <input checked="" type="checkbox"/>	1059	A9N2P50CIN <input checked="" type="checkbox"/>	2372	A9N3P50CIN <input checked="" type="checkbox"/>	3722	A9N4P50CIN <input checked="" type="checkbox"/>	4784
63	A9N1P63CIN <input checked="" type="checkbox"/>	1074	A9N2P63CIN <input checked="" type="checkbox"/>	2393	A9N3P63CIN <input checked="" type="checkbox"/>	3845	A9N4P63CIN <input checked="" type="checkbox"/>	4983
D curve								
2	A9N1P02DIN <input checked="" type="checkbox"/>	755	A9N2P02DIN <input checked="" type="checkbox"/>	2061	-	-	-	-
3	A9N1P03DIN <input checked="" type="checkbox"/>	755	-	-	A9N3P03DIN <input checked="" type="checkbox"/>	3269	-	-
4	A9N1P04DIN <input checked="" type="checkbox"/>	755	A9N2P04DIN <input checked="" type="checkbox"/>	2061	A9N3P04DIN <input checked="" type="checkbox"/>	3269	-	-
6	A9N1P06DIN <input checked="" type="checkbox"/>	637	A9N2P06DIN <input checked="" type="checkbox"/>	1545	A9N3P06DIN <input checked="" type="checkbox"/>	2575	-	-
10	A9N1P10DIN <input checked="" type="checkbox"/>	637	A9N2P10DIN <input checked="" type="checkbox"/>	1545	A9N3P10DIN <input checked="" type="checkbox"/>	2575	-	-
16	A9N1P16DIN <input checked="" type="checkbox"/>	637	A9N2P16DIN <input checked="" type="checkbox"/>	1545	A9N3P16DIN <input checked="" type="checkbox"/>	2575	A9N4P16DIN <input checked="" type="checkbox"/>	3415
20	A9N1P20DIN <input checked="" type="checkbox"/>	637	A9N2P20DIN <input checked="" type="checkbox"/>	1545	A9N3P20DIN <input checked="" type="checkbox"/>	2575	A9N4P20DIN <input checked="" type="checkbox"/>	3415
25	A9N1P25DIN <input checked="" type="checkbox"/>	637	A9N2P25DIN <input checked="" type="checkbox"/>	1545	A9N3P25DIN <input checked="" type="checkbox"/>	2575	A9N4P25DIN <input checked="" type="checkbox"/>	3415
32	A9N1P32DIN <input checked="" type="checkbox"/>	637	A9N2P32DIN <input checked="" type="checkbox"/>	1545	A9N3P32DIN <input checked="" type="checkbox"/>	2575	A9N4P32DIN <input checked="" type="checkbox"/>	3415
40	A9N1P40DIN <input checked="" type="checkbox"/>	1144	A9N2P40DIN <input checked="" type="checkbox"/>	2507	A9N3P40DIN <input checked="" type="checkbox"/>	3943	A9N4P40DIN <input checked="" type="checkbox"/>	4945
50	-	-	-	-	A9N3P50DIN <input checked="" type="checkbox"/>	3943	-	-
63	A9N1P63DIN <input checked="" type="checkbox"/>	1157	A9N2P63DIN <input checked="" type="checkbox"/>	2537	A9N3P63DIN <input checked="" type="checkbox"/>	3978	A9N4P63DIN <input checked="" type="checkbox"/>	4995

Please contact Customer Care Center for Stockable and Non stockable status of references.

NORMAL STOCK ITEMS

W.E.F. February 03rd, 2025

DC Miniature Circuit Breakers - C60H



- Specially designed MCB for enhanced protection in DC installation
- Magnetic Arc Chutes to quick break DC current in event of fault
- Breaking capacity 6kA as per IEC 60947-2
- Voltage Rating: 1P - 250 V DC & 2P - 500 V DC
- Impulse Voltage: 6 kV
- Higher Installation Life: Energy Limiting Class: 3

[In] Rated Current (A)	Module Width 18mm/ module	1 Pole Reference	Unit MRP [₹]	Module Width 18mm/ module	2 Pole Reference	Unit MRP [₹]
MOQ		12 Nos.		6 Nos.		
C60H-DC						
0.5	1	A9N61500	1873	2	A9N61520	4113
1	1	A9N61501 <input checked="" type="checkbox"/>	1366	2	A9N61521 <input checked="" type="checkbox"/>	2819
2	1	A9N61502 <input checked="" type="checkbox"/>	1366	2	A9N61522 <input checked="" type="checkbox"/>	2819
3	1	A9N61503 <input checked="" type="checkbox"/>	1366	2	A9N61523 <input checked="" type="checkbox"/>	2819
4	1	A9N61504 <input checked="" type="checkbox"/>	1366	2	A9N61524 <input checked="" type="checkbox"/>	2819
5	1	A9N61505	1366	2	A9N61525	2819
6	1	A9N61506 <input checked="" type="checkbox"/>	1122	2	A9N61526 <input checked="" type="checkbox"/>	2294
10	1	A9N61508 <input checked="" type="checkbox"/>	1122	2	A9N61528 <input checked="" type="checkbox"/>	2294
16	1	A9N61511 <input checked="" type="checkbox"/>	1122	2	A9N61531 <input checked="" type="checkbox"/>	2294
20	1	A9N61512 <input checked="" type="checkbox"/>	1122	2	A9N61532 <input checked="" type="checkbox"/>	2294
25	1	A9N61513 <input checked="" type="checkbox"/>	1122	2	A9N61533 <input checked="" type="checkbox"/>	2294
32	1	A9N61515 <input checked="" type="checkbox"/>	1293	2	A9N61535 <input checked="" type="checkbox"/>	2294
40	1	A9N61517 <input checked="" type="checkbox"/>	1538	2	A9N61537 <input checked="" type="checkbox"/>	3383
50	1	A9N61518 <input checked="" type="checkbox"/>	1538	2	A9N61538 <input checked="" type="checkbox"/>	3383
63	1	A9N61519 <input checked="" type="checkbox"/>	1538	2	A9N61539 <input checked="" type="checkbox"/>	3383

Special application MCBs



Solar Application – PV DC

- DC MCB for multi string PV installations
- Operating Voltage: 800V DC
- Current Rating up to 25A
- Complies to IEC / EN 60947-2

Rail Application* (including Rolling Stock)

- Fire & smoke Resistant – Level 2 (NF F 16-101, NF F 16-102)
- Shock & vibration resistant (IEC 61373) – Cat 1, Class B
- Breaking Capacity: up to 25kA
- Complies to IEC / EN 60947-2

UL MCB

- Type: UL1077, UL489
- Breaking Capacity of 10kA
- Complies to IEC 60947-2 / UL1077 / UL489 / CSA

Note:

Please contact nearest Schneider Electric sales office or Customer Care for Reference and prices of Application Specific MCBs

*Rail Application RCDs are also available on demand **18mm/module

Residual Current Devices (RCDs) - For Human and Fire Protection



**30
mA**

Use of **30mA RCDs** is now **mandatory** for all **domestic intallations** in India {CEA Amendment regulation 2015*}



Schneider Electric provides voltage independent RCDs which work on current sensing technology and provide protection from residual current even at extra low voltages (down to zero volts) and in case of break of neutral.

**SI
Type**

Schneider Electric offers SI RCD built to operate in electrically polluted or installation in aggressive environments:

- Flourescent / Variable lighting with Electronic ballast
- Powerful IT / Telecom equipment / Air conditioning
- Severe Atmosphere - High lighting risk / Swimming pools

* for Measures relating to Safety and Electric supply

AC Residual Current Circuit Breakers - xID



Suitable for
ComReady
Auxiliary



- Complies to standards IEC/EN 61008-1 and IS 12640
- AC Class protection
- Selective range available for time based discrimination
- Easy Monitoring: Earth fault indication and Test Button on front face
- Operating temperature up to +70°C
- Mandatory to use OF-S auxiliary to add any indication or tripping auxiliary

[In] Rated Current (A)	Earth-Leakage Sensitivity (mA)	Module Width 18mm/module	2 Pole Reference	Unit MRP [₹]	Module Width 18mm/module	4 Pole Reference	Unit MRP [₹]
25	30	2	A9N16201	4776	4	A9N16251	6704
	100	2	A9N16203	5301	4	A9N16253	7124
	300	2	A9N16202	5462	4	A9N16252	7334
40	30	2	A9N16204	5622	4	A9N16254	6599
	100	2	A9N16205	6061	4	A9N16255	7164
	300	2	A9N16206	6357	4	A9N16256	7440
63	30	2	A9N16208	6770	4	A9N16258	7642
	100	2	A9N16209	7281	4	A9N16259	8464
	300	2	A9N16210	7427	4	A9N16260	8503
80	30	2	A9N16212	11381	4	A9N16261	13480
	100	2	A9N16213	11570	4	A9N16262	13697
	300	2	A9N16214	11787	4	A9N16263	13770

AC Residual Current Circuit Breakers (RCCBs) - ID



- Complies to standards IEC 61008-1 and VDE 0664
- AC Class protection
- Degree of pollution: 3 (suitable for industrial environment)
- Electrical ON/OFF indication by using OFSP auxiliary

Poles Description	[In] Rated Current (A)	Earth-Leakage Sensitivity (mA)	Module Width 18mm/module	Reference	Unit MRP [₹]
4P	100	30	4	**A9R11491	-
		100	4	**A9R12491	-
	125	30	4	A9R11492	58072
		100	4	A9R12492	56541
		300	4	A9R14492	56805

Note: **For 100A RCCB Auxiliary kindly contact Customer Care

AC Residual Current Breaker Overload (RCBO) - DPN N Vigi



Suitable for
ComReady
Auxiliary



- Complies to standards IEC/EN 61009
- AC Class Protection; Tripping characteristics - C curve
- Overvoltage category (IEC 60364): IV
- Suitable for indication & tripping auxiliaries

Poles Description	[In] Rated Current (A)	Earth-Leakage Sensitivity (mA)	Module Width 18mm/module	Reference	Unit MRP [₹]
1P+N	6	30	2	A9N19661	7585
		300	2	A9N19681	7704
	10	30	2	A9N19663	7585
		300	2	A9N19683	7704
	16	30	2	A9N19665	7585
		300	2	A9N19685	7704
	20	30	2	A9N19666	7585
		300	2	A9N19686	7704
	25	30	2	A9N19667	7585
		300	2	A9N19687	7704
	32	30	2	A9N19668	7585
		300	2	A9N19688	8088
	40	30	2	A9N19669	9596
		300	2	A9N19689	9763

Note: Application specific RCDs also available with 10mA, 500mA and 1000mA sensitivities

Please contact nearest Schneider Electric Sales Office or Customer Care Center for Reference and Prices

Please contact Customer Care Center for Stockable and Non stockable status of references.

✓ NORMAL STOCK ITEMS

W.E.F. February 03rd, 2025

SI Type Residual Current Circuit Breakers (RCCBs) - xID SI



- Complies to standard IEC/EN 61008-1
- SI RCDs offer enhanced immunity against Electrical Disturbances; Polluted and Corrosive environments - Guaranteed performance in harsh operating conditions
- Ensures continuity of supply in networks with:
 - Transient overvoltages
 - Loads generating HF leakage current i.e. harmonics
 - Loads generating continuous leakage current
- Ensures tripping on genuine earth fault in networks with:
 - Pulsating DC components
 - HF applications which "Blinds" (non-tripping) the conventional RCDs

[In] Rated Current (A)	Earth-Leakage Sensitivity (mA)	Module Width 18mm/module	2 Pole Reference	Unit MRP [₹]	Module Width 18mm/module	4 Pole Reference	Unit MRP [₹]
25	30	2	A9N16234	11111	4	A9N16321	12383
40	30	2	A9N16237	11670	4	A9N16324	12774
63	30	2	A9N16240	12006	4	A9N16327	13116
63	300	2	A9N16246	12096	4	-	-

Vigi Block for xC60 (Add-on RCD Module, 2 & 4 Pole)



- Flexibility to use MCB of any tripping curve to suit applications, ensuring best 3 in 1 protection
- No auxiliary supply required
- AC Class protection
- Degree of pollution: 3 (suitable for industrial environment)
- Immune to nuisance tripping due to transient over voltages

[In] Rated Current (A)	Earth-Leakage Sensitivity (mA)	Module Width 18mm/module	2 Pole Reference	Unit MRP [₹]	Module Width 18mm/module	4 Pole Reference	Unit MRP [₹]
25	30	1.5	A9N26581	8748	3	A9N26595	10027
	100	1.5	A9N26582	9995	3	A9N26596	10176
	300	1.5	A9N26583	10568	3	A9N26597	10952
63	30	2	A9N26611	10987	3.5	A9N26643	11028
	100	2	A9N26612	11635	3.5	A9N26644	11454
	300	2	-	-	3.5	A9N26645	11984

Note: Vigi Block for High Rating up to 125A (C120) and High Breaking Capacity (NG125) available on demand

SI Type Residual Current Breaker Overload (RCBO) - DPN N Vigi SI



- Complies to standard IEC/EN 61009
- Ensures continuity of supply in networks with:
 - Transient overvoltages
 - Loads generating HF leakage current i.e. harmonics
 - Loads generating continuous leakage current
- Ensures tripping on genuine earth fault in networks with :
 - Pulsating DC components
 - HF applications which "Blinds" (non-tripping) the conventional RCDs

Poles Description	[In] Rated Current (A)	Earth-Leakage Sensitivity (mA)	Module Width 18mm/module	Reference	Unit MRP [₹]
1P+N	6	30	2	A9N19631	15100
	10	30	2	A9N19632	15100
	16	30	2	A9N19634	15100
		300	2	A9N19644	15100
	25	30	2	A9N19636	15100
	32	30	2	A9N19637	15100
	40	30	2	A9N19638	17879
		300	2	A9N19648	19896

*For Prices, please contact nearest Schneider Electric Sales Office or Customer Care Center are Center for Reference and Prices

Please contact Customer Care Center for Stockable and Non stockable status of references.

NORMAL STOCK ITEMS

W.E.F. February 03rd, 2025

Common Auxiliaries for xC60 / C120 / RCDs Range

- Field-fittable auxiliaries (clip fitted) mounted on left side with maximum width of 54mm
- Order: Tripping Auxiliaries (MN first) followed by Indication Auxiliaries (SD first)

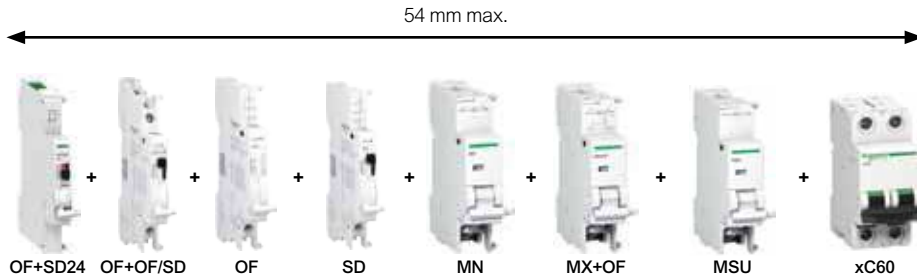

Type	Module Width 18mm/module	Reference	Unit MRP [₹]
Indication Auxiliaries			
Acti9 A9A iOF bottom wiring 0.1-6A aux	0.5	A9N26904	1484
Acti9 A9N SD bottom wiring 0.1-6A aux	0.5	A9N26907	1817
Acti9 A9N OF/SD+OF top/bt wir 0.1-6A aux	0.5	A9N26909	4627
Acti9 A9A iOF bottom wiring 0.1-6A aux	0.5	A9A26904	1519
Acti9 A9A iOF/SD+OF t&b wire 0.1-6A aux	0.5	A9A26909	4916
Acti9 A9N OF+SD 24V DC Ti24 term on top	0.5	A9N26899	4073
Protection Auxiliaries – Trip Indication on front face			
Voltage Release MN 220-240V AC DC Ghost		A9N26960	6544
Voltage Release MSU 270V AC	1	A9N26500	7749
Tripping Auxiliaries – Trip Indication on front face			
Acti9 MX-OF 100-415VAC 110-130V DC Shunt	1	A9N26946	4257
MX Shunt Trip MX Plus 1 of 24V AC DC CCC		A9N26948	4257
Auxiliary Switch for RCCBs – Mandatory for use of Auxiliaries with RCCBs			
Auxiliary Contact 1 OCS	0.5	A9N26923	6233
Acti9 OFSP Auxiliary Contact	0.5	A9N16940	3070

Accessories



Type	Description	Reference	Unit MRP [₹]
Rotary Handle*	Breaker Switching Sub-Assembly	27046	7050
Rotary Handle*	Extended, Disconnectable handle	27047	3560
Padlock** (bag of 2)		26970	1385
Multicable terminal for 3 copper cables**		19096	11459
Aluminum cable terminal**		27060	830
Spacer		A9N27062	350

* for xC60, C120, DPN N Vigi, C60H-DC, xSW - Multi poles only

**for xC60, xID, DPN N Vigi, C60H-DC, xSW, C60PV-DC

Note:

For all above Reference MOQ = 1

Please contact Customer Care Center for Stockable and Non stockable status of references.

NORMAL STOCK ITEMS

W.E.F. February 03rd, 2025

Protection Against Lightning Strikes And Switching Surges



For all low voltage switchboards and electrical enclosures:

Comprehensive range

- To ensure the protection of equipment connected to:
- Low voltage networks,
- Telecommunications networks,
- Computer networks.
- Easy to implement and use.
- Compatibility with all earthing systems (TT, TNS, TNC, IT).
- Technical and aesthetic consistency

Continuity of service and certified safety

Schneider Electric certified coordination between the surge arrester and its disconnection circuit breaker.

Compliance with standards: IEC/EN 61643-11.



More and more electrical equipment today is sensitive to overvoltages caused by lightning.



90%

of power outlets supply equipment incorporating electronic devices.



iQuick PRD “built-in” technology surge arresters, a Schneider Electric innovation, incorporate their own disconnection circuit breaker: easy to choose and simple to install for greater effectiveness.



Up to **30%** of installation time saved.

Surge Arresters - Type 1+ 2



- Complies to IEC 61643-1 and EN 61643-11
- Withdraw able type: Easy Replacement
- Inbuilt SPD health Indicator: Also available with remote signaling
- For protection against Direct lightning surge, Indirect lightning surge, Switching surge
- Iimp up to 25kA & Imax upto 40kA
- **Always use a Back-up MCB with your SPD**
- Maximum Operating Voltage [Uc]: 350V

Type	Pole Description	Module Width 18mm/module	Reference	Unit MRP ₹
PRD1 25r	1P	2	16329	24252
	1P + N	4	16330	43533
	3P	6	16331	68547
	3P + N	8	16332	85166

Surge Arresters iPRD - Type 2 (Withdrawable type) (TT, TN-S, TN-C Systems)



- In conformance with standards IEC 61643-11/2011 T2 and EN 61643-11 Type 2
- For protection against Indirect lightning surge and Switching surge
- Inbuilt health Indicator
- Response time < 25ns
- Imax (8/20 s): 65/40/15/8kA
- Maximum Operating Voltage [Uc]: 340V
- Level of protection, Up: 1.0 - 2.0 kV
- Remote indication contact with 8r/20r/40r/65r
- **Always use a Back-up MCB with your SPD**

Type	Rated Voltage (V)	Pole Description	Module Width 18mm/module	Reference	Unit MRP ₹
iPRD8	230	1P	1	A9L08100	5941
	230	1P+N	2	A9L08500	11332
	230/400	3P	3	A9L08300	15295
	230/400	3P+N	4	A9L08600	23086
iPRD8r	230	1P+N	2	A9L08501	13585
	230/400	3P+N	4	A9L08601	27704
iPRD20	230	1P	1	A9L20100	6659
	230	1P+N	2	A9L20500	14245
	230/400	3P	3	A9L20300	18235
iPRD20r	230/400	3P+N	4	A9L20600	25781
	230	1P+N	2	A9L20501	16689
	230/400	3P+N	4	A9L20601	31525
iPRD40	230	1P	1	A9L40100	8267
	230	1P+N	2	A9L40500	16407
	230/400	3P	3	A9L40300	23550
iPRD40r	230/400	3P+N	4	A9L40600	32839
	230	1P	1	A9L40101	9256
	230	1P+N	2	A9L40501	21151
iPRD65r	230/400	3P	3	A9L40301	31693
	230/400	3P+N	4	A9L40601	39414
	230	1P	1	A9L65101	12374
iPRD65r	230	1P+N	2	A9L65501	26957
	230/400	3P	3	A9L65301	35177
	230/400	3P+N	4	A9L65601	45644

Spare Cartridges for iPRD



- Spare Cartridges for iPRD8r, iPRD20r, iPRD40r and iPRD65r
- End of life indication available on front face
- These Cartridges are not compatible with Old SPD range (A9L16...)**

Type	Spare Cartridges for	Reference	Unit MRP ₹
iPRD 65-350	iPRD65r	A9L65102	7901
iPRD 40-350	iPRD40, iPRD40r	A9L40102	6383
iPRD 20-350	iPRD20, iPRD20r	A9L20102	4872
iPRD Neutral	All products (1P+N, 3P+N)	A9L00002	6524

**Spare Cartridges for Old SPD Range (A9L16...) are available on demand - please contact nearest Schneider Electric Sales Office or Customer Care for Reference and prices

Note:

For all above Reference MOQ = 1

Please contact Customer Care Center for Stockable and Non stockable status of references.

NORMAL STOCK ITEMS

W.E.F. February 03rd, 2025

iQuick PRD - Type 2 with inbuilt MCB



- Compact SPD with in-built back up MCB - saving on space, MCB selection, wiring time
- Compliance to EN 61643-11
- Withdrawable Type - Cost Efficient - Allows damaged Cartridges to be replaced without having to replace entire SPD
- Inbuilt SPD Health Indicator on front face of device; Remote signaling functionality also available
- Incoming Protection: iQuick PRD 40r (High Risk level) and iQuick PRD 20r (Moderate Risk level)
- Secondary Protection: iQuick PRD 8r is cascade mounted with incoming surge arresters

Type	Pole Description	Module Width 18mm/module	Reference	Unit MRP [₹]
iQuick PRD 8r	1P+N	4	A9L16298	17065
	3P	6.5	A9L16299	25590
	3P+N	7.5	A9L16300	31842
iQuick PRD 20r	1P+N	4	A9L16295	19510
	3P	6.5	A9L16296	30720
	3P+N	7.5	A9L16297	38211
Quick PRD 40r	1P+N	4	A9L16292	24403
	3P	6.5	A9L16293	36559
	3P+N	7.5	A9L16294	45435

Note: Spare / Replacement Cartridges available - For Reference and prices contact nearest sales office or customer care

Photovoltaic Surge Arresters



- Protection for photovoltaic panels and the DC input to the inverter from overvoltages due to a lightning strike
- Type 2 surge arresters
- Should be installed in switchboard inside the building. If switchboard is located outside, it must be weatherproof
- Withdrawable surge arrester allows damaged Cartridges to be replaced quickly
- Inbuilt SPD Health Indicator on front face of device; Remote signaling functionality also available

Type	U (cqv) Maximum Operating Voltage (V)	Module Width 18mm/module	Reference	Unit MRP [₹]
iPRD 40r	800	3	A9L40271	12975
	1000	3	A9L40281	15882

Note: Spare / Replacement Cartridges available - For Reference and prices contact nearest sales office or customer care

Surge Arresters for Communication Networks



- Analogue telephone line protection: iPRC surge arrester wired in series to the private installation input, protects the telephones, the modems (including ADSL) etc
- Protection for 2 low-current lines without common potential or 4 lines with common reference potential
- iPRI protects measuring instrument and PLC sensor inputs and the DC power supply inputs up to 53 V and AC power supply inputs up to 37 V

Type	[Ue] Operational Voltage (V)	Module Width 18mm/module	Reference	Unit MRP [₹]
PRI	48 V DC	1	A9L16339	23606
PRC	130 V AC	1	A9L16337	14152

Note:

For all above Reference MOQ = 1

Please contact Customer Care Center for Stockable and Non stockable status of references.

NORMAL STOCK ITEMS

W.E.F. February 03rd, 2025

Isolator - xSW



- Complies to IEC/EN 60947-3
- Switching duty: AC-22
- Impulse voltage: 6kV
- DC application: 48V (110V with 2 poles in series)
- Short circuit withstand 20 In for 1 second
- Upto 80A Bi connect terminals & 100A to 125A with mono connect terminals

Poles Description	[In] Rated Current (A)	Module Width 18mm/module	MOQ	Reference	Unit MRP [₹]
2	40	2	6	A9S2P040	951
	63	2	6	A9S2P063	1257
3	40	3	4	A9S3P040	1662
	63	3	4	A9S3P063	1947
4	40	4	3	A9S4P040	2104
	63	4	3	A9S4P063	2291
	100	4	3	A9S4P100	3833
	125	4	3	A9S4P125	4236

Selector Switch - iSSW



- Complies to IEC 60947-5-1 and IEC 60669-1
- Rating 20A, 250V AC
- Electrical life (AC22): 30,000 cycles
- Connection: tunnel terminals cables up to 10 sq. mm

No. of positions	Poles Description	Contacts	Module Width 18mm/module	MOQ	Reference	Unit MRP [₹]
2	1	1 C/O	1	12	A9E18070	2035
	2	2 C/O	2	6	A9E18071	2798
	2	1NO + 1NC	1	12	A9E18072	1631
3	1	1 C/O	1	12	A9E18073	1868
	2	2 C/O	2	6	A9E18074	3376

iRO Buzzers



- Audible indication in housing and the tertiary sector
- Sound level of 70dBA at a distance of 60cm

Voltage	Module Width 18mm/module	Reference	Unit MRP [₹]
230V AC	1	A9A15322	2515

Please contact Customer Care Center for Stockable and Non stockable status of references.

NORMAL STOCK ITEMS

W.E.F. February 03rd, 2025

iCT Contactors



- Complies with standards IEC 1095, E N 61095
- 4 operating modes switch on front face :
 - Automatic mode
 - Temporary "ON" mode
 - Permanent "ON" mode
 - Shutdown
- Mechanical contact position Indicator
- Safe installation maintenance: lock the contactor in ON position
- Silent operation (20dB) for entire range

Type	Rating (A)	No. of Contacts	Module Width 18mm/module	Reference	Unit MRP [₹]
1P	25	1NO	1	A9C20731	2985
	16	2NO	1	A9C22712	3072
2P	25	2NO	1	A9C20732	3673
	40	2NO	2	A9C20842	7485
	63	2NO	2	A9C20862	8029
3P	25	3NO	2	A9C20833	4733
	40	3NO	2	A9C20843	10507
	63	3NO	3	A9C20863	11419
4P	25	4NO	2	A9C20834	4956
	40	4NO	2	A9C20844	12238
	63	4NO	3	A9C20864	12911
	63	2NO + 2NC	3	A9C20868	14382

Note: 100A Contactor in 2P / 4P - available on request

iTL Impulse Relays



- Complies with standards IEC/EN 60669-2-2
- Safe maintenance: disconnection of remote control by selector switch
- Manual Controls on front face: 0-I toggle
- Mechanical contact position Indicator
- Maximum 5 operations/min. and 100 switching operations/day
- Degree of pollution: 3 (suitable for industrial environment)

Type	Rating (A)	Control Voltage	No. of Contacts	Module Width	Reference	Unit MRP [₹]
1P	16	230-240 VAC	1NO	1	A9C30811	1935
	32	230-240 VAC	1NO	1	A9C30831	2436
2P	16	230-240 VAC	2NO	1	A9C30812	3174
	32	230-240 VAC	2NO	1	A9C30831 + A9C32836	7215
3P	16	230-240 VAC	1NO+1NO/NC+1NO	2	A9C30811 + A9C32816	5769
	32	230-240 VAC	1NO+1NO/NC+1NO	2	A9C30831 + 2 x A9C32836	11994
4P	16	230-240 VAC	4NO	2	A9C30814	6135
	32	230-240 VAC	4NO	2	A9C30831 + 3 x A9C32836	16773

iIL Indicator Lights



- Complies with standard IEC 60947-5-1
- Indicator light with LED technology
- Service life 100,000 hours with constant luminous efficiency

Type	Colour	Module Width 18mm/module	Reference	Unit MRP [₹]
Single Indicator light	Red	1	A9E18320	2001
	Green	1	A9E18321	2001
	Blue	1	A9E18323	2001
	Orange	1	A9E18324	2001
3 phase voltage presence light	Red/Red/Red	1	A9E18327	5781
Single Push Button (1 NO+ 1NC)	Grey	1	A9E18033	2695

Note: For all above Reference MOQ = 1

Please contact Customer Care Center for Stockable and Non stockable status of references.

NORMAL STOCK ITEMS

W.E.F. February 03rd, 2025

Communication Auxiliaries



Description	Module Width	Reference	Unit MRP [₹]
OF+SD24	0.5	A9N26899	4073
iACT24	1	A9C15924	18734
iATL24	1	A9C15424	19726

Acti 9

Description	Reference	Pack	Unit MRP [₹]
Distribloc 63A			
Distribution from the top (4 Module)	04040	1	16350
Distribution through the bottom (4 Module)	04041	1	16350

Reflex iC60 - Integrated Control & Overcurrent Protection Device



- All in One Solution: MCB + Contactor + Impulse Relay + Auxiliary
- 10kA Breaking capacity as per IEC/EN 60947-2,
- Ti24 interface: Connection to PLC, Smartlink
- 3 operating modes to cater to a variety of applications
- Safe lock down with Integrated Padlocking
- Simplified maintenance: Front face Indicator allows better reliability

[In] Rated Current (A)	2 Pole Reference	Unit MRP [₹]	3 Pole Reference	Unit MRP [₹]	4 Pole Reference	Unit MRP [₹]
Module Width **	4.5 mod		5.5 mod		6.5 mod	
B Curve						
10	A9C61210	51536	-	-	-	-
C Curve						
10	A9C62210	54720	A9C62310	55466	A9C62410	58878
16	A9C62216	54720	A9C62316	56581	A9C62416	58878
25	A9C62225	52107	A9C62325	55466	A9C62425	58878
40	A9C62240	54881	-	-	A9C62440	64369
63	-	-	-	-	A9C62463	66044
D Curve						
25	-	-	-	-	A9C63425	61243

Note: **18mm/module

Please contact Customer Care Center for Stockable and Non stockable status of references.

NORMAL STOCK ITEMS

W.E.F. February 03rd, 2025

EcoStruxure™ Innovation At Every Level

From sensors to services, our Innovation At Every Level approach improves energy and operational efficiency by tapping the true business value of IoT advancements. We've made mobility, sensing, cloud, analytics, and cyber security technologies meaningful to customers, helping them compete in our IoT economy.

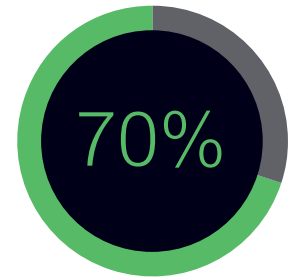

70%
of decision-makers see the business value of IoT*

*Schneider Electric IoT 2020 Business Report

Connected Products:

The Internet of Things starts with the best things. Our IoT-enabled best-in-class connected products include breakers, drives, UPSs, relays, sensors, and more. Devices with embedded intelligence drive better decision-making throughout operations.

Edge Control:

Mission-critical scenarios can be unpredictable, so control of devices at the edge of the IoT network is a must. This essential capability provides real-time solutions that enable local control at the edge, protecting safety and uptime.

Applications, Analytics, and Services:

Interoperability is imperative to supporting the diverse hardware and systems in building, data center, industry, and grid end markets. EcoStruxure™ enables a breadth of agnostic applications, analytics, and services for seamless enterprise integration.

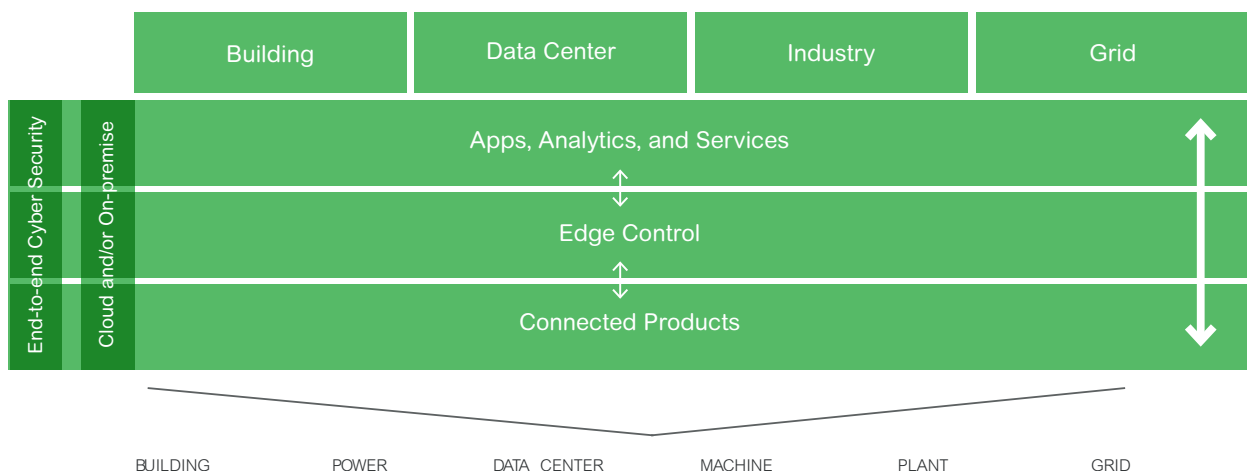

Connectivity built in

Acti9 Isobar harnesses the connectivity of the Acti9 range enabling distribution boards to become smart and connected.



1. **Enable asset management** on all outgoing ways with **PowerTag**



2. **Smartlink SiD** for wireless data concentration



3. **Enable further asset and energy management** through PowerTag for Compact NSX



4. **Monitor and control** your assets with SiB Smartlink



5. See the power and optimise the use of your assets with Facility Expert our **simple on-line services platform**

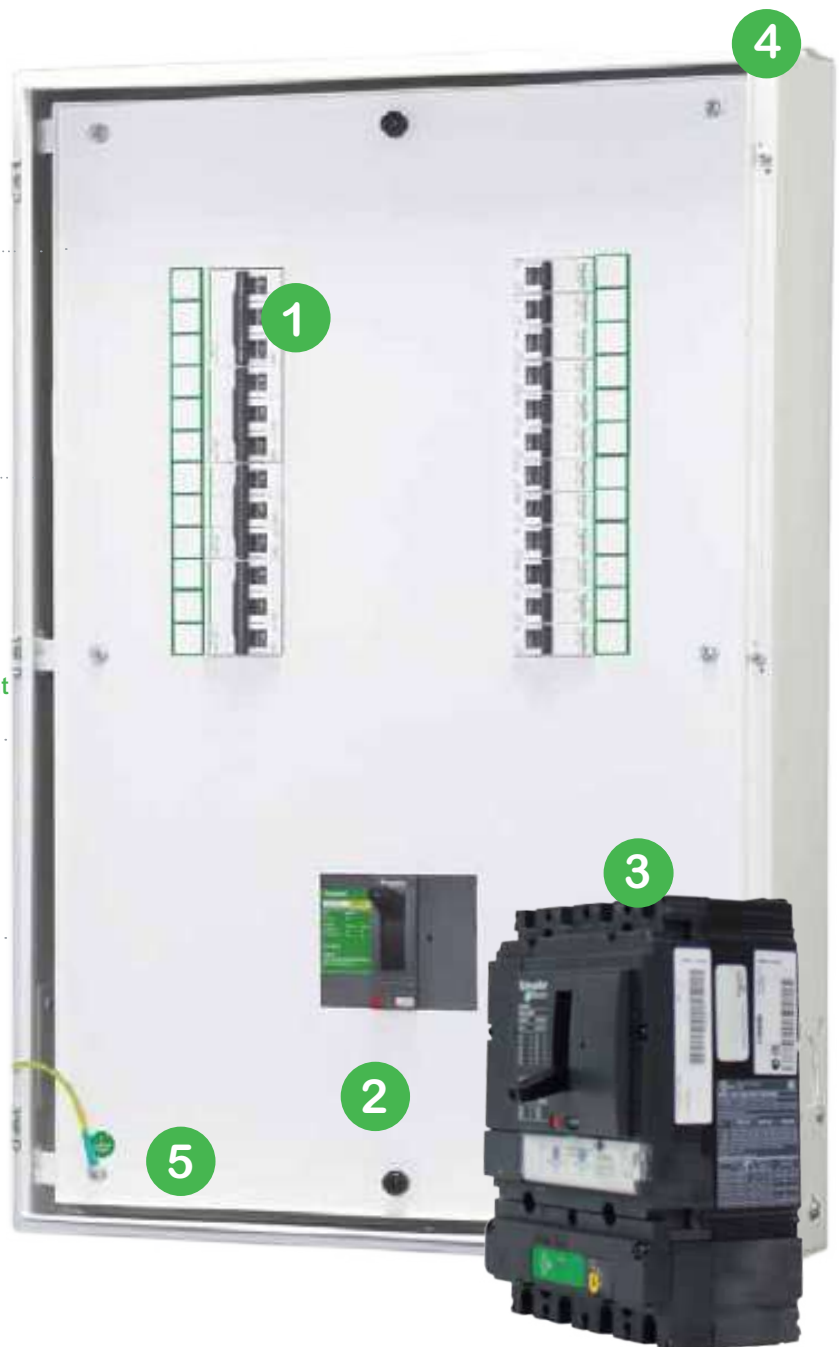

Acti 9

Isobar Pan Assembly

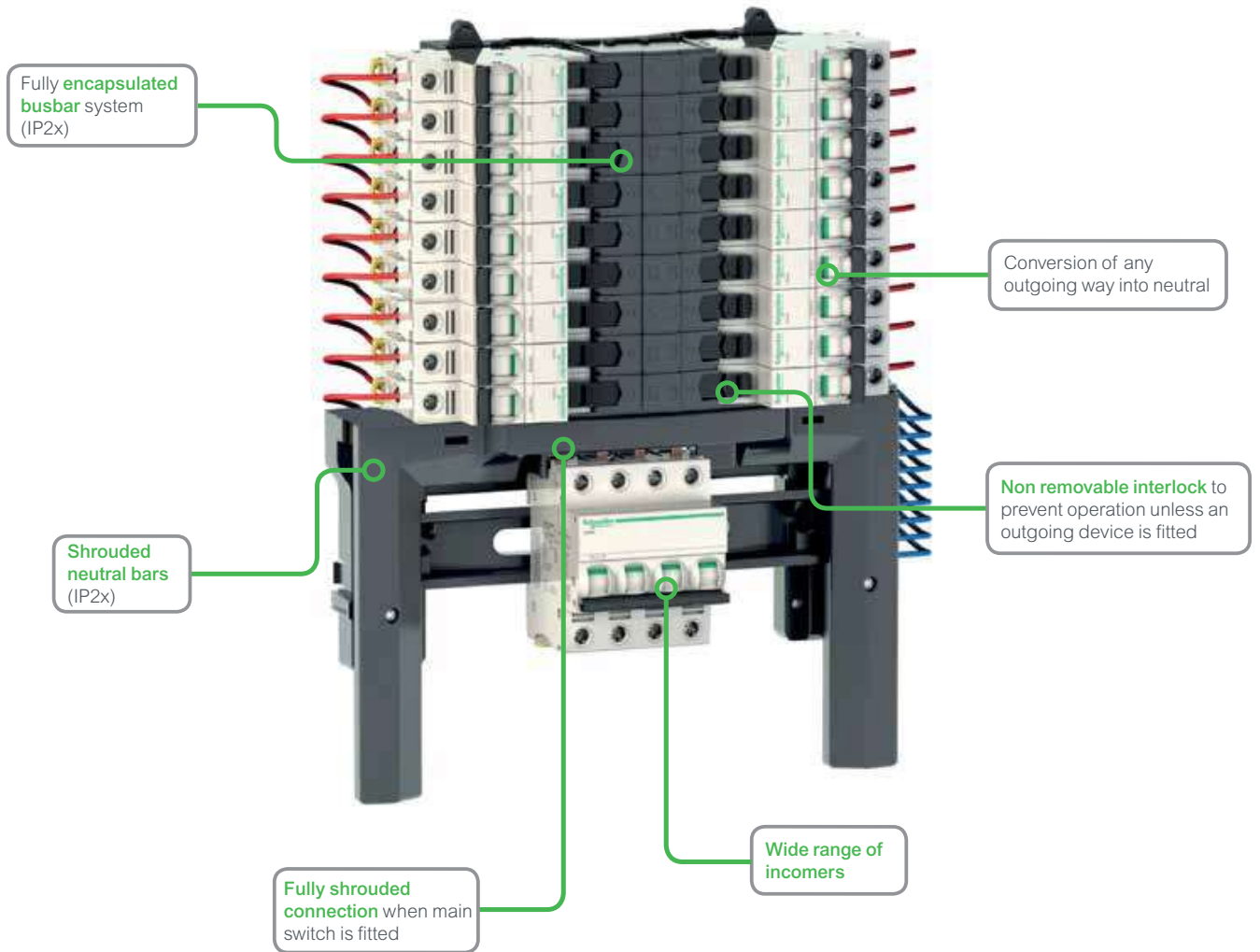

- Fully type tested conditional short circuit rating of 25kA to BS EN 61439-3
- High performance MCB 10kA BS EN 60898 15kA BS EN 60947-2 in B, C or D curve 1, 2, 3, 4 pole
- 250A busbar rating
- Isobar disconnection to BS EN 60947-3 ensuring unused outgoing ways are isolated
- Option of switching outgoing neutral on all boards using distributed neutral kit
- Range of incomers: switch disconnectors, residual current devices, terminal blocks, mccb
- Single pole RCBO for new or retrofit maintaining device density
- Full range of device accessories and auxiliaries
- Shrouded Neutral
- Convention of any outgoing way into Neutral

Description	Double Door Metal (IP43) Reference	Unit LP [₹]
Acti9 Isobar B - pan assembly - 16 ways TP + earth + neutral	SEA9BN16PEV	*
Acti9 Isobar B - pan assembly - 18 ways TP + earth + neutral	SEA9BN18PEV	*
Acti9 Isobar B - pan assembly - 24 ways TP + earth + neutral	SEA9BN24PEV	*
Acti 9 - 1P blank terminal block (no electrical connection)	SEA9BP	*
Isobar B - neutral bar - 1N - for distribution board - 16 ways	SEA9NB16	*
Isobar B - neutral bar - 1N - for distribution board - 18 ways	SEA9NB18	*
Isobar B - neutral bar - 1N - for distribution board - 24 ways	SEA9NB24	*
Isobar A - neutral bar - 1N - for distribution board - 4 ways SP+N	SEA9NKIT	*
Acti 9 - terminal block - 250A	SEA9NPB250TB	*
Acti 9 Isobar B - MCCB/Interpact connection kit	SEA9BINCKIT	*

*Price on Request

Please contact Schneider Electric Customer Care Center for Prices

Acti 9

Distribution Boards

Spectacular Design

Blends seamlessly with interiors



Unique Rounded Corners | Color - RAL 9003 white | Designer Rotary Knob

Maximized Wiring Space

Convenient and Safe wiring

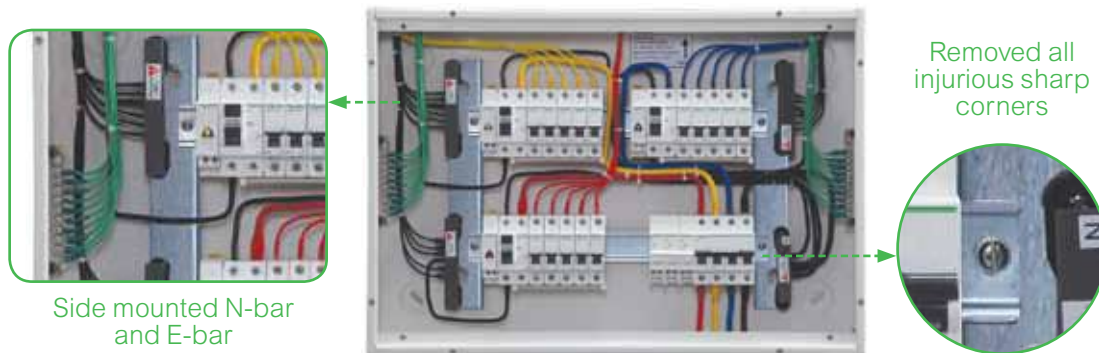

15% more wiring area | Reduced U-box Collar | Removable Frame, Centre plate & Gland plate

Adaptable

Total Flexibility for ease of installation and usage

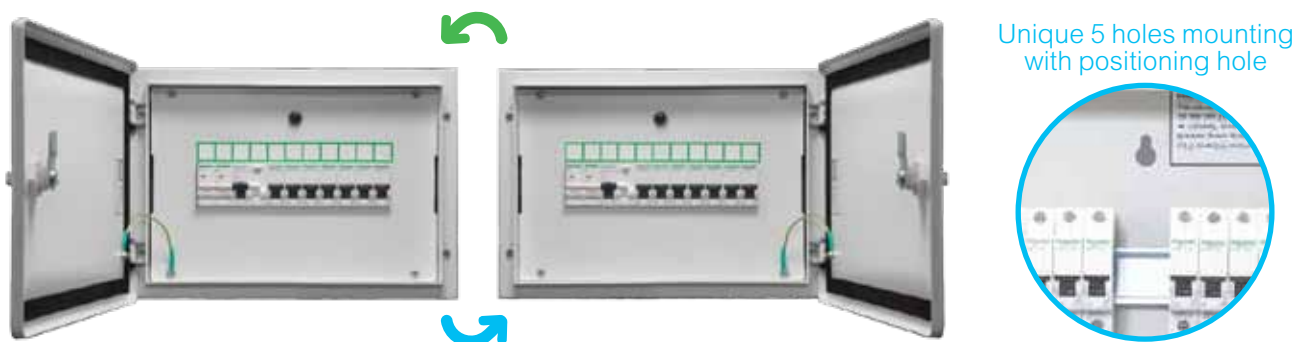

Surface and Flush installation | Field fittable key lock provision | Reversible Door

Robust Architecture

Perfect blend of Strength & Weight



High Strength-to-Weight ratio | RoHS and REACH Compliance – ideal solution for GREEN Buildings

Base Material used - Galvanized Iron

4X Rust Resistance



1. Powder Coating
- 2. Galvanized Iron**
3. Base Iron

Galvanized Iron | Gives 4X rust resistance
No Rusting | Even if the powder coating is scratched
No Propagation Of Rust | Even If base material is chipped off
No Hassle | of repainting due to rusting

Inspiring the **S.M.A.R.T.** choice!!!

Technically Proven

Safety Guaranteed



Designed and Manufactured as per **IS 8623 - 1 & 3** | IP and IK test by ERDA & CPRI | Glow wire tested

Type Tested as per IEC 61439 - 1 & 3



IEC 61439 - 3* Fully Compliant

*Tested at **NABL** and **ASTA** accredited testing facility



Salt Spray



IP43



IK09



Reliable Door



Earthing



Temp@
Max Curr

Mechanical Tests

Electrical Tests

Acti 9

Distribution Boards

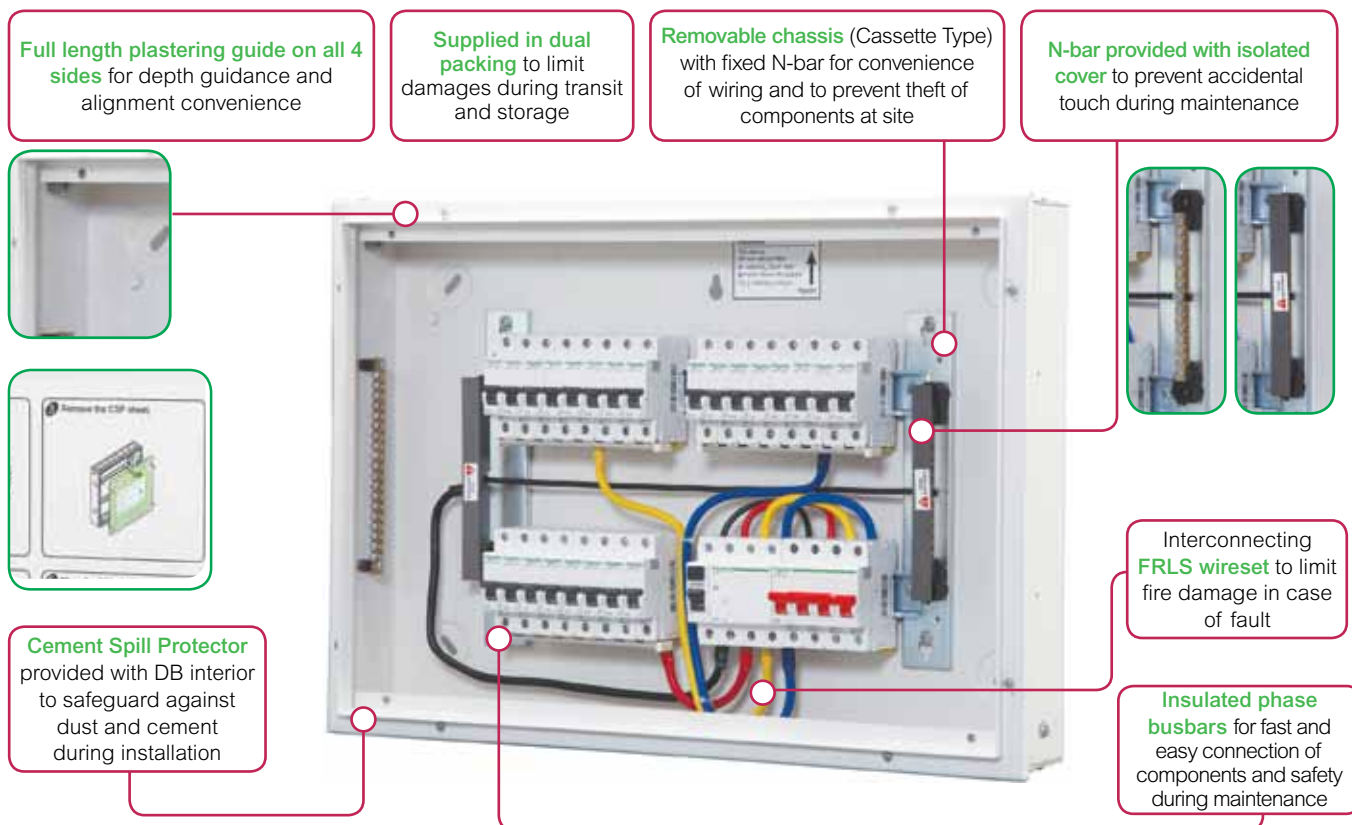
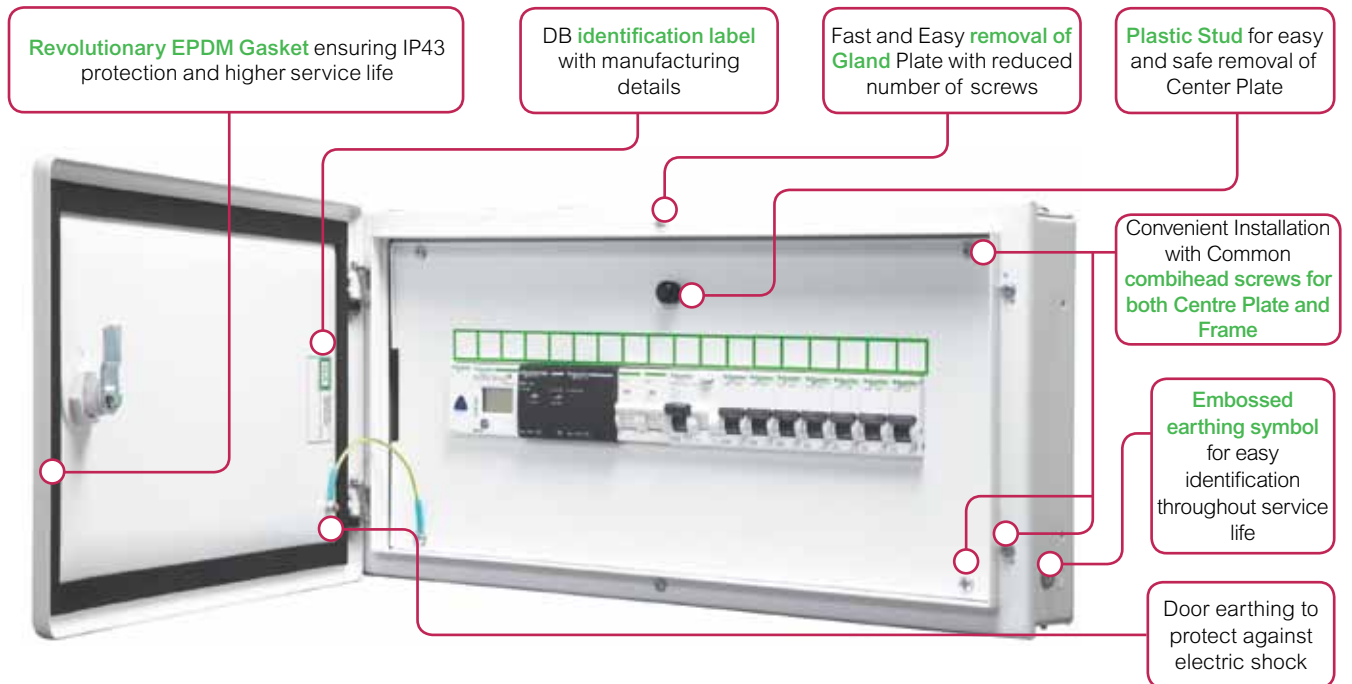

Metal Enclosures



- Metal Enclosure to mount individual Modular Device feeding directly to the load or final distribution board

Description	Total Module Cutout	Single Door (IP30) Reference	Unit MRP [₹]
2 way	1 / 2	A9HMES02 <input checked="" type="checkbox"/>	1102
4 way	3 / 4	A9HMES04 <input checked="" type="checkbox"/>	1102

SPN DBs



- SPN DB for distribution of Single Phase Neutral supply to respective load MCBs
- Incomer - DP RCCB/RCBO/Isolator/MCB
- Outgoing - SP MCBs

Description	Total Module Cutout (Incomer + Outgoing)	Single Door (IP30) Reference	Unit MRP [₹]	Double Door Metal (IP43) Reference	Unit MRP [₹]
6 way	6	A9HSNS06	2135	A9HSND06 <input checked="" type="checkbox"/>	3067
8 way	8	A9HSNS08 <input checked="" type="checkbox"/>	2532	A9HSND08 <input checked="" type="checkbox"/>	3343
12 way	12	A9HSNS12	2996	A9HSND12 <input checked="" type="checkbox"/>	4020
18 way	18	-	-	A9HSND18 <input checked="" type="checkbox"/>	5386

TPN DBs



- Standard TPN DBs for distribution of Three Phase and Neutral supply
- Incomer - FP RCCB/RCBO/Isolator/MCB
- Outgoing - SP MCBs

Description	Total Module Cutout (Incomer + Outgoing)	Single Door (IP30) Reference	Unit MRP [₹]	Double Door Metal (IP43) Reference	Unit MRP [₹]
4 way eco	4 + 12	-	-	A9HTND04E <input checked="" type="checkbox"/>	8002
4 way	8 + 12	-	-	A9HTND04 <input checked="" type="checkbox"/>	8071
6 way	8 + 18	-	-	A9HTND06 <input checked="" type="checkbox"/>	8191
8 way	8 + 24	-	-	A9HTND08 <input checked="" type="checkbox"/>	10100
12 way	8 + 36	-	-	A9HTND12 <input checked="" type="checkbox"/>	15420

Flexi Tier DBs



- Flexi DBs give total flexibility to mount any type and size of Modular devices as per load requirement
- Provided with N-Bar and E-Bar
- Flexi Tier DBs can be converted to PPI DB using 'PPI Kit' provided on next page

Description	Total Module Cutout (Incomer + Outgoing)	Single Door (IP30) Reference	Unit MRP [₹]	Double Door Metal (IP43) Reference	Unit MRP [₹]
2 Tier 24 Modules	2 x 12	-	-	A9HFD224	8649
3 Tier 36 Modules	3 x 12	-	-	A9HFD336	10388
4 Tier 40 Modules	4 x 10	-	-	A9HFD440 <input checked="" type="checkbox"/>	10974
4 Tier 56 Modules	4 x 14	-	-	A9HFD456 <input checked="" type="checkbox"/>	11470

Note:

For all above Reference MOQ = 1
Please contact Customer Care Center for Stockable and Non stockable status of references.

NORMAL STOCK ITEMS

W.E.F. February 03rd, 2025

Acti 9

Distribution Boards

New Phase Segregated DBs

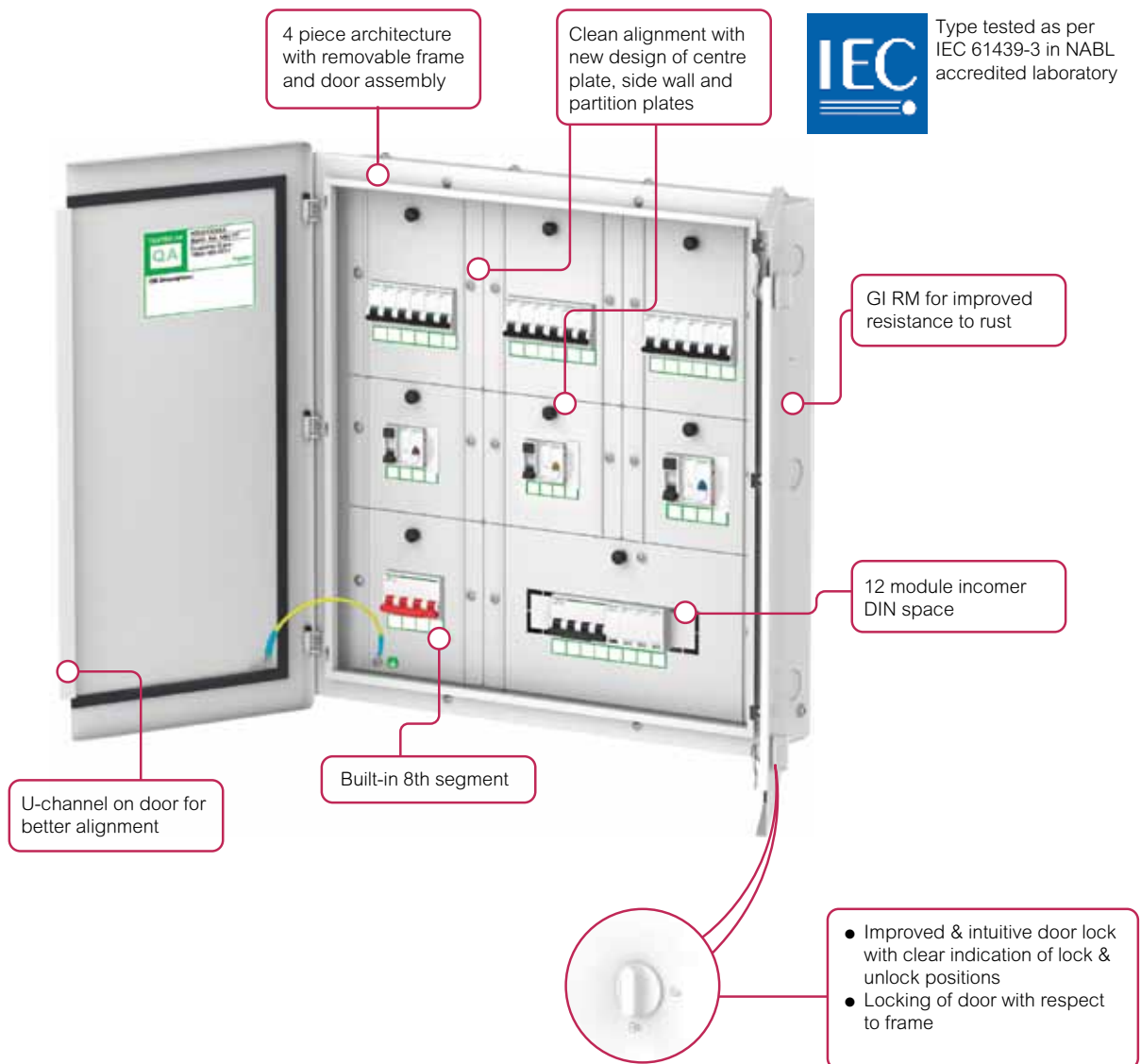

Key highlights

- 1 New compact design
- 2 Robust architecture
- 3 Type-tested system
- 4 4 piece construction
- 5 Built-in 8th segment
- 6 Split door for all variants
- 7 Clean alignment of doors, centerplates
- 8 Improved door locking
- 9 High rust resistance with GI
- 10 Increased incomer DIN space

Per Phase Isolation DBs

- PPI DBs to mount DP Residual Current Device (RCD) at an individual phase level to isolate the faulty phase in case of earth leakage and ensure continuity of supply to other healthy phases
- Incomer - Modular (FP MCB/Isolator) MCCB100A (TP/FP Compact NSX or EasyPact CVS)
- Sub-Incomer - DP RCCB/RCBO
- Outgoing - SP MCBs

PPI TPN DB



Description	Total Module Cutout (no. of rows x No. of modules per row)	Double Door Metal (IP43)	No of Ways	Unit MRP [₹]
6 Way TPN PPI DB	8 + 2 x 3 + 4 x 3	A9HTPI06	6 Ways	10653
8 Way TPN PPI DB	8 + 2 x 3 + 6 x 3	A9HTPI08	8 Ways	12356
12 Way TPN PPI DB	8 + 2 x 3 + 10 x 3	A9HTPI12	12 Ways	16999

PPI Flexi Tier DB

Description	Total Module Cutout (no. of rows x No. of modules per row)	Double Door Metal (IP43)	No of Ways	Unit MRP [₹]
4T40M Flexi PPI DB	4 x 10	A9HFPI10	10	16496
4T56M Flexi PPI DB	4 x 14	A9HFPI14	14	18573

Phase Segregated DBs



- Phase Segregated DBs to provide total safety for installer and maintenance personnel, by compartmentalizing each Phase and separating Incomer, Sub-Incomer and Outgoing
- Offers better continuity of supply in case of faults during maintenance at DB level.
- Incomer - Modular (FP MCB/Isolator) / MCCB 100A (TP/FP during maintenance Compact NSX or EasyPact CVS)
- Sub-Incomer - DP RCCB/RCBO
- Outgoing - SP MCBs
- GI sheet ensures improved rust resistance
- Type-tested system conforming IEC 61439-3
- Built-in 8th segment (for modular incomer only)
- Increased incomer DIN space of 12M for 6 ways to 12 ways
- Split door for all variants
- New design ensures clean alignment of doors, centerplates
- 4 piece architecture with removable frame
- Improved, intuitive door lock design with clear indication of lock and unlock positions

Description	Total Module Cutout (Additional segment + Incomer + Sub-incomer + Outgoing)	Double Door Metal (IP43) Reference	Unit MRP [₹]
4 way	4 + 8 + (3*4) + (3*4)	A9HPSG04	16066
6 way	4 + 12 + (3*4) + (3*6)	A9HPSG06	17964
8 way	4 + 12 + (3*4) + (3*8)	A9HPSG08	20058
12 way	4 + 12 + (3*4) + (3*12)	A9HPSG12	25179
12 way with MCCB I/c	0 + 100A MCCB + (3*4) + (3*12)	A9HPSG12M	33976

Note:

For all above Reference MOQ = 1
Please contact Customer Care Center for Stockable and Non stockable status of references.

VTPN DBs for Modular Incomer



- Ideal solution to distribute power supply to both 3 Phase and 1 Phase loads in the same DB
- Incomer - FP RCCB / RCBO / Isolator / MCB
- Outgoing - SP MCBs / TP MCBs
- 65% more Incomer Wiring Space.
- New Compact Fishbone with better Thermal Performance
- Short Circuit Withstand – 17 kA for 250mS (100 A)/ 25 kA (250 A) for 500mS
- Secure Connections with Fixed Spreader links
- IP 2X protection at Incomer with new shrouds
- Type tested as per IEC 61439 – 3 in NABL accredited Lab
- Knockout size for Incomer increased to 50mm (to accommodate Aluminium Cable)

Description	Total Module Cutout (Incomer + Outgoing)	Double Door Metal (IP43) Reference	No of Ways	Unit MRP [₹]
Acti9 VTPN DB 4 Ways Modular i-c 63A	12 + 12	A9HVM04	4 Ways	15633
Acti9 VTPN DB 8 Ways Modular i-c 63A	12 + 24	A9HVM08	8 Ways	19894
Acti9 VTPN DB 12 Ways Modular i-c 63A	12 + 36	A9HVM12	12 Ways	26613

VTPN DBs for MCCB Incomer



- DBs for higher incoming current distribution up to 250A
- Incomer - TP/FP Compact NSX or EasyPact CVS MCCB up to 250A
- Outgoing - SP MCBs / TP MCBs
- 65% more Incomer Wiring Space.
- New Compact Fishbone with better Thermal Performance
- Short Circuit Withstand – 17 kA for 250mS (100 A)/ 25 kA (250 A) for 500mS
- Secure Connections with Fixed Spreader links
- IP 2X protection at Incomer with new shrouds
- Type tested as per IEC 61439 – 3 in NABL accredited Lab
- Knockout size for Incomer increased to 50mm (to accommodate Aluminium Cable)

Description	Total Module Cutout (Incomer + Outgoing)	Double Door Metal (IP43) Reference	No of Ways	Unit MRP [₹]
Acti9 VTPN DB 4 Ways MCCB i-c 100A	100 A MCCB + 12	A9HVN04L	4 Ways	17119
Acti9 VTPN DB 4 Ways MCCB i-c 160A	160 A MCCB + 12	A9HVN04M	4 Ways	18847
Acti9 VTPN DB 8 Ways MCCB i-c 100A	100 A MCCB + 24	A9HVN08L	8 Ways	21697
Acti9 VTPN DB 8 Ways MCCB i-c 160A	160 A MCCB + 24	A9HVN08M	8 Ways	23478
Acti9 VTPN DB 8 Ways MCCB i-c 250A	250 A MCCB + 24	A9HVN08H	8 Ways	30099
Acti9 VTPN DB 12 Ways MCCB i-c 100A	100 A MCCB + 36	A9HVN12L	12 Ways	28842
Acti9 VTPN DB 12 Ways MCCB i-c 160A	160 A MCCB + 36	A9HVN12M	12 Ways	31332
Acti9 VTPN DB 12 Ways MCCB i-c 250A	250 A MCCB + 36	A9HVN12H	12 Ways	35605

Mivan Compatible DB

SPN DBs

Description	Total Module Cutout (Incomer + Outgoing)	Double Door Metal (IP43) Reference	No of Ways	Unit MRP [₹]
Acti9 DB 6 way SPN DD 1.6mm	2 + 4	A9HSND06Z	6 Ways	On Request
Acti9 DB 8 way SPN DD 1.6mm	2 + 6	A9HSND08Z	8 Ways	On Request
Acti9 DB 12 way SPN DD 1.6mm	2 + 10	A9HSND12Z	12 Ways	On Request
Acti9 DB 18 way SPN DD 1.6mm	2 + 16	A9HSND18Z	18 Ways	On Request

TPN DBs

Description	Total Module Cutout (Incomer + Outgoing)	Double Door Metal (IP43) Reference	No of Ways	Unit MRP [₹]
Acti9 DB 4 way TPN DD 1.6mm	8 + 4 x 3	A9HTND04Z	4 Ways	On Request
Acti9 DB 6 way TPN DD 1.6mm	8 + 6 x 3	A9HTND06Z	6 Ways	On Request
Acti9 DB 8 way TPN DD 1.6mm	8 + 8 x 3	A9HTND08Z	8 Ways	On Request
Acti9 DB 12 way TPN DD 1.6mm	8 + 12 x 3	A9HTND12Z	12 Ways	On Request

Please contact Customer Care Center for Stockable and Non stockable status of references.

NORMAL STOCK ITEMS

W.E.F. February 03rd, 2025

Phase Segregated DBs (Mivan Compatible)

Description	Total Module Cutout (Additional segment + Incomer + Sub-incomer + Outgoing)	Double Door Metal (IP43) Reference	No of Ways	Unit MRP [₹]
Acti9 DB 4 way PSG DD 1.6mm	4 + 8 + (3*4) + (3*4)	A9HPSG04Z	4 ways	On Request
Acti9 DB 6 way PSG DD 1.6mm	4 + 12 + (3*4) + (3*6)	A9HPSG06Z	6 ways	On Request
Acti9 DB 8 way PSG DD 1.6mm	4 + 12 + (3*4) + (3*8)	A9HPSG08Z	8 ways	On Request
Acti9 DB 12 way PSG DD 1.6mm	4 + 12 + (3*4) + (3*12)	A9HPSG12Z	12 ways	On Request

Flexi Tier DBs (Mivan Compatible)

Description	Total Module Cutout (no. of rows x No. of modules per row)	Double Door Metal (IP43) Reference	No of Modules Per Row	Unit MRP [₹]
4 Tier 40 Modules	4 x 10	A9HFD440Z	10	On Request
4 Tier 56 Modules	4 x 14	A9HFD456Z	14	On Request

TV TEL DB

Description	Double Door Metal (IP30) Reference	Unit MRP [₹]
Acti9 DB TVTEL BOX 1mm IP30	A9HTVTEL	On Request
Acti9 DB TVTEL & ONT BOX 1.2MM IP30	A9HOTVTEL	On Request

Note: For all above Reference MOQ = 1

Metal Clad P&S Units

- Plug & Socket Unit with Electra Plug & Socket and provision to mount modular protection devices to feed the end load directly

Description	Total Module Cutout	Single Door (IP30) Reference	Unit MRP [₹]
10A 1P+N+E P&S	2	A9HMS210	2806
20A 1P+N+E P&S	2	A9HMS220	3002
30A 3P+E P&S	3	A9HMS330	6572

Please contact Customer Care Center for Stockable and Non stockable status of references.

NORMAL STOCK ITEMS

W.E.F. February 03rd, 2025

Industrial P&S Units (provision to mount PratiKa Sockets)



- Plug & Socket Unit with provision to mount PratiKa straight / angled* socket and modular protection devices to feed the end load directly

Description	Total Module Cutout	Single Door (IP30) Reference	Unit MRP [₹]
16A 3P PK P&S	2	A9HKS316	2594
32A 3P PK P&S	2	A9HKS332	4285
32A 5P PK P&S	4	A9HKS532	5075
63A 5P PK P&S	4	A9HKS563	10247

Locks for Acti 9 DBs

Key Lock*



Lock & Unlock symbol on door for easy & intuitive operation

Description	Reference	Unit MRP [₹]
New Rotary Lock**	A9HRL901	835

Note: **Use New Rotary lock reference A9HRL901 for:
Acti9 DBs manufactured September 2020 onwards
Acti9 DBs with lock & unlock symbol on door.

Accessories for Distribution Boards

Wire Way Box for Double Door IP43 DBs

Description	Reference	Unit MRP [₹]
Wire way box for A9HSND06 AC 848	A9HSND06WB	2065
Wire way box for A9HSND08 AC 848	A9HSND08WB	2496
Wire way box for A9HSND12 AC 848	A9HSND12WB	2783
Wire way box for A9HSND18 AC 848	A9HSND18WB	3974
Wire way BOX FOR A9HTND04E - PM 163	A9HTND04EWB	2868
Wire way box for A9HTND04 AC 849	A9HTND04WB	3171
Wire way box for A9HTND06 AC 849	A9HTND06WB	3363
Wire way box for A9HTND08 AC 849	A9HTND08WB	3974
Wire way box for A9HTND12 AC 849	A9HTND12WB	4642
Wire way BOX FOR A9HFD224 AC 850	A9HFD224WB	2957
Wire way BOX FOR A9HFD336 AC 850	A9HFD336WB	2927
Wire way BOX FOR A9HFD440 AC 850	A9HFD440WB	2830
Wire way BOX FOR A9HFD456 AC 850	A9HFD456WB	3171
WWB Acti9 PSG DB 8 Seg 4 Ways MCB i/c	A9HPSG04WWB	4091
WWB Acti9 PSG DB 8 Seg 6 Ways MCB i/c	A9HPSG06WWB	4787
WWB Acti9 PSG DB 8 Seg 8 Ways MCB i/c	A9HPSG08WWB	5355
WWB Acti9 PSG DB 8 Seg 12 Ways MCB i/c	A9HPSG12WWB	6941
WWB Acti9 PSG DB 7 Seg 12 Ways MCCB i/c	A9HPSG12MWWB	7413
WWB for Std VTPN DB MCB i/c AC034	A9HVMXXWB	3009
WWB for Std VTPN DB MCCB i/c AC035	A9HVNXXWB	3203

Modular Distribution Boards - Metallic

Description	Reference	Unit MRP [₹]
Busbars		
Fork Busbar 1P 12MOD. 63A	R9XFH112	1129
Fork Busbar 1P 57MOD. 63A	R9XFH157	2513
Fork Busbar 2P 12MOD. 63A	R9XFH212	1301
Fork Busbar 2P 57MOD. 63A	R9XFH257	4820
Fork Busbar 3P 12MOD. 63A	R9XFH312	2937
Fork Busbar 3P 57MOD. 63A	R9XFH357	10513
Fork Busbar 4P 12MOD. 63A	R9XFH412	2709
Fork Busbar 4P 57MOD. 63A	R9XFH457	11314
Busbar Accessories		
Set of 10 End Caps 1P	R9XE110	*
Set of 10 End Caps 2P	R9XE210	*
Set of 10 End Caps 3P	R9XE310	1188
Set of 10 End Caps 4P	R9XE410	*
Set of 20 Tooth Caps	R9XT20	1427
Blanking Plate	13229B	59

Note: Blanking Plate MOQ = 10, All other MOQ = 1

Customized Distribution Boards to Suit Your Need - Available on Request*

- TV/Telephone DBs
- Pre-Wired DBs
- 8 Segment DBs
- Acrylic Door DBs
- IP54 DBs
- DBs with Phase Indication Lamps

*upto 32A socket only

Note:

For all above Reference MOQ = 1

*Please contact nearest Schneider Electric Sales Office or Customer Care Center for coordination chart

Please contact Customer Care Center for Stockable and Non stockable status of references.

NORMAL STOCK ITEMS

W.E.F. February 03rd, 2025

Timers & Time Switches

Analog Time Switches



- 24H, 7D Programmable switch Voltage Rating: 230V AC +10%, -15%
- Memory: Upto 56 Switching Operations
- Back up of program: Operating reserve for 100, 200 Hours
- Overall dimensions: 5 modules
- Minimum time between two switching operations: 15, 30 min
- Accuracy: $\leq \pm 1$ s/day at +20°C

Description	Module Width 18mm/module	Reference	Unit MRP [₹]
IH 24H 16 A 15 mts interval 1 channel	1	15336	5979
IH 24H 16 A 30 mts interval 1 channel	1	CCT15365	6522
IH 7 day 16 A 1 channel- Max 21 On and 21 Off cycles	3	CCT15367	9336
IH 24H 16 A 30 mts 1 channel without reserve	3	CCT16364	5297

Digital Time Switches



- 7D, 24H Programmable switch .Voltage Rating: 230V AC +10%, -15%
- Consumption: 1 channel - max. 4VA; 2 channels - max. 7VA
- Memory: Upto 56 Switching Operations
- Back up of program & time by lithium battery: Operating reserve: 6 Years
- Overall dimensions: 5 modules
- Cable length: 100m
- Minimum time between two switching operations: 1 min

Description	Module Width 18mm/module	Reference	Unit MRP [₹]
IHP 1C w (24h/7d) programmable time switch	2.5	CCT15441	12851
IHP+ 1C (24h/7d) SMARTw programmable time switch	2.5	CCT15551	15854
IHP 2C w (24h/7d) programmable time switch	2.5	CCT15443	16577
IHP DCF (24h/7d) SMART programmable time switch	2.5	CCT15858	26096
IHP+ 2C (24h/7d) SMARTw programmable time switch	2.5	CCT15553	18341

Timers



- Switching capacity 16 A, max
- Delay range from 30 sec to 20 min
- Capacity for lighted pushbutton 150 mA
- Electric distribution busbar compatibility
- Output power capacity CCT15232-2300W
- Output power capacity CCT15223-3600W

Description	Module Width 18mm/module	Reference	Unit MRP [₹]
MINs - electronic timer - 0.5 to 20 min	1	CCT15232	7259
MINs - electronic timer - 0.5 to 20 min with switch Off Warning	1	CCT15233	9322
MINs - electronic timer - 0.5 to 20 min with switch Off Warning and Impulse relay function	1	CCT15234	8762

Please contact Customer Care Center for Stockable and Non stockable status of references.

Timers & Time Switches

Twilight switch



- Includes wall mounted cell
- Adjustable brightness threshold 2 to 2000 Lux
- 2 LEDs to signal the sensor status and the output status
- Test button: To check the product and load cabling
- Switching capacity: 16Amp
- Screwless Terminals compatible with rigid and flexible wires
- Consumption 6 VA
- Size 45mm

Description	Module Width 18mm/module	Reference	Unit MRP [₹]
IC2000 outdoor (2 - 2000 lux) twilight switch	1	CCT15369	15310
Analogue indoor light sensor cell	-	CCT15262	7555
Wall mounted Analogue outdoor light sensor cell	-	CCT15263	11710
IC100 (2 - 100 lux) twilight switch	1	CCT15482	12879
IC2000 indoor (2 - 2000 lux) twilight switch	1	CCT15285	11478
IC2000p+ (2 - 2000 lux) programmable twilight switch	2.5	CCT15483	26603
IC100kp+ 1C (1 - 99000 lux) SMART programmable twilight switch	2.5	CCT15494	32175
IC100kp+ 2C (1 - 99000 lux) SMART programmable twilight switch	2.5	CCT15495	39610
IC Astro 2C SMART programmable twilight switch	2.5	CCT15245	27808
IC Astro 1C SMART programmable twilight switch	2.5	CCT15225	23399

Time switch accessories

Description	Module Width 18mm/module	Reference	Unit MRP [₹]
Programming kit for IHP / IC	1	CCT15860	12240

Thermostat

Description	Module Width 18mm/module	Reference	Unit MRP [₹]
THP1+ 1C (24h/7d) programmable thermostat	2.5	CCT15834	27842

Please contact Customer Care Center for Stockable and Non stockable status of references.

W.E.F. February 03rd, 2025

Kaedra enclosures for PratiKa industrial sockets are part of a complete system of Watertight enclosures from 16A to 125A providing solutions for protection, control and electrical distribution for tertiary and industrial applications



- Degree of protection - IP65
- Impact strength - IK09
- Resistant to chemical and atmospheric agents, UVs etc.
- Self extinguishing class 2 insulating material
- Flame and abnormal heat resistance: 650°C
- Reversible front face for opening of door to left/right
- Combining of enclosures horizontally/vertically while still maintaining IP
- DIN channel can be positioned in 2 depths & 2 heights for cabling purpose

Mini Enclosures for modular devices



Description	Reference	Unit MRP [₹]
4 module	13441 <input checked="" type="checkbox"/>	4457
6 module	13442	5073
8 module	13443	5973
12 module	13444	9598

Enclosures for modular devices (with terminal blocks)



Description	Reference	Unit MRP [₹]
1 row 12 module	13431	10592
1 row 18 module	13432	13961
2 row 24 module	13433	15854
2 row 36 module	13434	20070
3 row 36 module	13435	20927
4 row 72 module	13437	39942

Mini Enclosure (suitable to mount modular devices and PratiKa 16A socket)



Description	Reference	Unit MRP [₹]
4 module 1 vertical opening	13175 <input checked="" type="checkbox"/>	2126
4 module 2 horizontal opening	13176	2623
4 module 3 horizontal opening	13177	3301

Note: For all above Reference MOQ = 1

Please contact Customer Care Center for Stockable and Non stockable status of references.

NORMAL STOCK ITEMS

W.E.F. February 03rd, 2025

Enclosure (suitable to mount modular devices and PratiKa 16A / 32A sockets)



Description	Reference	Unit MRP [₹]
5 module 2 opening	13178 <input checked="" type="checkbox"/>	5118
8 module 4 horizontal opening	13179	6986
13 module 3 opening	13180	9231
13 module 6 opening	13181	10147
19 module 8 opening	13182	13077

Functional Plaques



Description	Reference	Unit MRP [₹]
Blank - marked for 1 socket 50x50	13135	662
Blank - marked for 1 socket 65x65 or 75x75	13137	662
Intermediate with 65x85 opening	13136	807
Intermediate with one opening for 65x85 & 90x100	13142	1339

Note: For all above Reference MOQ = 1

Please contact Customer Care Center for Stockable and Non stockable status of references.

NORMAL STOCK ITEMS

W.E.F. February 03rd, 2025

Wander Plugs



- Conforms to IEC 60309-1 & IEC 60309-2
- PK PratiKa Screw Connect: same orientation of clamp's screws
- External impact strength: IK08
- Glow wire test: 850°C

[In] Rated Current (A)	[Ue] Rated Operational Voltage (V)	Poles Description	Reference	Unit MRP [₹]
PratiKa Screw				
IP44				
16	200...250	2P + E	PKE16M423 <input checked="" type="checkbox"/>	631
		2P + E	PKX16M423 ●	1287
	380...415	3P + E	PKE16M434 <input checked="" type="checkbox"/>	806
		3P + N + E	PKE16M435 <input checked="" type="checkbox"/>	840
32	200...250	2P + E	PKE32M423 <input checked="" type="checkbox"/>	992
	380...415	3P + E	PKE32M434 <input checked="" type="checkbox"/>	1163
		3P + N + E	PKE32M435 <input checked="" type="checkbox"/>	1136
IP67				
16	200...250	2P + E	PKE16M723 <input checked="" type="checkbox"/>	1378
		2P + E	PKX16M723 ●	2048
	380...415	3P + E	PKE16M734 <input checked="" type="checkbox"/>	1572
		3P + N + E	PKE16M735 <input checked="" type="checkbox"/>	1680
32	200...250	2P + E	PKE32M723 <input checked="" type="checkbox"/>	1969
	380...415	3P + E	PKE32M734 <input checked="" type="checkbox"/>	2124
		3P + N + E	PKE32M735 <input checked="" type="checkbox"/>	2120
PK (63A & 125A available in IP67 only)				
63	200...250	2P + E	81378	5582
	380...415	3P + E	81382 <input checked="" type="checkbox"/>	5321
		3P + N + E	81383 <input checked="" type="checkbox"/>	5279
125	380...415	3P + E	81394	16278
		3P + N + E	81395	16278

Note: * Fast Connection

Small Wall Mounted Sockets



- Conforms to IEC 60309-1 & IEC 60309-2
- External impact strength: IK08
- Glow wire test: 850°C

[In] Rated Current (A)	[Ue] Rated Operational Voltage (V)	Poles Description	Reference	Unit MRP [₹]
IP44				
16	200...250	2P + E	PKF16W423 <input checked="" type="checkbox"/>	1115
		3P + E	PKF16W434 <input checked="" type="checkbox"/>	1294
	380...415	3P + N + E	PKF16W435 <input checked="" type="checkbox"/>	1413
		200...250	2P + E	PKF32W423 <input checked="" type="checkbox"/>
32	380...415	3P + E	PKF32W434	1749
		3P + N + E	PKF32W435 <input checked="" type="checkbox"/>	1847
IP67				
16	200...250	2P + E	PKF16W723	1771
		3P + E	PKF16W734	2225
	380...415	3P + N + E	PKF16W735	2301
		200...250	2P + E	PKF32W723 <input checked="" type="checkbox"/>
32	380...415	3P + E	PKF32W734	3237
		3P + N + E	PKF32W735	4293

Note: For all above Reference MOQ = 1

Please contact Customer Care Center for Stockable and Non stockable status of references.
*Bold references are MTO reference.

Wall Mounted Sockets



- Conforms to IEC 60309-1 & IEC 60309-2
- Rated operational voltage upto 415V
- Rated operational current upto 125A
- External impact strength: IK08
- Glow wire test: 850°C
- Available only in IP67

[In] Rated Current (A)	[Ue] Rated Operational Voltage (V)	Poles Description	Reference	Unit MRP [₹]
63	200...250	2P + E	81178	6876
		3P + E	81182 ●	7077
	380...415	3P + N + E	81183	7179
125	380...415	3P + E	81194	24799
		3P + N + E	81195	24920

Wander Sockets



- PK PratiKa Screw Connect: same orientation of clamp's screws.
- PK PratiKa: 16A & 32A; IP44 & IP67
- External impact strength: IK08
- Glow wire test: 850 °C
- Conforms to IEC 60309-1 & IEC 60309-2

[In] Rated Current (A)	[Ue] Rated Operational Voltage (V)	Poles Description	Reference	Unit MRP [₹]
PratiKa Screw				
IP44				
16	200...250	2P + E	PKF16M423 ✓	882
		2P + E	PKY16M423	972
	380...415	3P + E	PKF16M434	1017
		3P + N + E	PKF16M435	1110
32	200...250	2P + E	PKF32M423 ✓	1213
		3P + E	PKF32M434	1472
	380...415	3P + N + E	PKF32M435 ✓	1482
IP67				
16	200...250	2P + E	PKF16M723	1633
		2P + E	PKY16M723 ●	1987
	380...415	3P + E	PKF16M734	2048
		3P + N + E	PKF16M735	2140
32	380...415	2P + E	PKF32M723	2246
		3P + E	PKF32M734	2485
	3P + N + E	PKF32M735	2508	
PK (63A & 125A available in IP67 only)				
63	200...250	2P + E	81478	6080
		3P + E	81482	6133
	380...415	3P + N + E	81483	6173
125	380...415	3P + E	81494	19192
		3P + N + E	81495	19568

Also Available on Request:

- Patented FAST connect Plugs & Sockets - innovative cabling system that enables connection without stripping the conductor and with absolutely no screws required
- Extra Low Voltage Plugs & Sockets down to 50V

Please contact nearest Schneider Electric Sales Office or Customer Care for Reference and Prices

Note: For all above Reference MOQ = 1

Please contact Customer Care Center for Stockable and Non stockable status of references.

*Bold references are MTO reference.

Panel Mounted Sockets - Angled



PKF16F423



PKF32F723



81283

- PK PratiKa Screw Connect: same orientation of clamp's screws
- External impact strength: IK08
- Glow wire test: 850°C
- Conforms to IEC 60309-1 & IEC309-2

[In] Rated Current (A)	[Ue] Rated Operational Voltage (V)	Poles Description	Reference	Unit MRP [₹]
PratiKa Screw				
IP44				
16	200...250	2P + E	PKF16F423 <input checked="" type="checkbox"/>	676
		2P + E	PKY16F423 ●	736
	380...415	3P + E	PKF16F434	1017
		3P + N + E	PKF16F435 <input checked="" type="checkbox"/>	1085
32	200...250	2P + E	PKF32F423 <input checked="" type="checkbox"/>	1201
		3P + E	PKF32F434	1407
	380...415	3P + N + E	PKF32F435	1388
		IP67		
16	200...250	2P + E	PKF16F723 <input checked="" type="checkbox"/>	1273
		2P + E	PKY16F723 ●	1557
	380...415	3P + E	PKF16F734	1464
		3P + N + E	PKF16F735 <input checked="" type="checkbox"/>	1482
32	200...250	2P + E	PKF32F723	1673
		3P + E	PKF32F734	1955
	380...415	3P + N + E	PKF32F735	1968
		PK (63A & 125A available in IP67 only)		
63	200...250	2P + E	81278	5489
		3P + E	81282 <input checked="" type="checkbox"/>	5498
	380...415	3P + N + E	81283 <input checked="" type="checkbox"/>	5553
125	380...415	3P + E	81294	18519
		3P + N + E	81295	18432

Panel Mounted Sockets - Straight



PKF16G423



PKF16G723



81683

- PK PratiKa Screw Connect: same orientation of clamp's screws
- External impact strength: IK08
- Glow wire test: 850°C
- Conforms to IEC 60309-1 & IEC309-2

[In] Rated Current (A)	[Ue] Rated Operational Voltage (V)	Poles Description	Reference	Unit MRP [₹]
PratiKa Screw				
IP44				
16	200...250	2P + E	PKF16G423	773
		2P + E	PKY16G423	1146
	380...415	3P + E	PKF16G434	1348
		3P + N + E	PKF16G435	1163
32	200...250	2P + E	PKF32G423	1227
		3P + E	PKF32G434	1413
	380...415	3P + N + E	PKF32G435	1531
		IP67		
16	200...250	2P + E	PKF16G723	1294
		2P + E	PKY16G723 ●	1457
	380...415	3P + E	PKF16G734	1779
		3P + N + E	PKF16G735	1482
32	200...250	2P + E	PKF32G723	1650
		3P + E	PKF32G734	1856
	380...415	3P + N + E	PKF32G735	1926
		PK (63A & 125A available in IP67 only)		
63	380...415	3P + E	81682	5552
		3P + N + E	81683	5552
125	380...415	3P + N + E	81695	18609

*Fast Connection

Note: For all above Reference MOQ = 1

Please contact Customer Care Center for Stockable and Non stockable status of references.

*Bold references are MTO reference.

Sockets with Interlock Switches - for guaranteed safety of operation

- Allows closure of main switch only when the plug is fully inserted in socket - when complete mechanical & electrical connection has occurred
- Plug removal is possible only when the switch is in "off" position

Wall Mounted Sockets with Interlock Switch Unika (w/o protection)



83047

83081

- Switch designed for use in AC 22A class applications
- Conforms to IEC 60309-1 & IEC 60309-2
- Rated operational voltage upto 415V
- Rated operational current upto 32A
- External impact strength: IK08
- Available in IP44 / IP65 versions
- Glow wire test: 750°C

[In] Rated Current (A)	[Ue] Rated Operational Voltage (V)	Poles Description	Reference	Unit MRP [₹]
IP44				
16	200...250	2P + E	83031	9279
	380...415	3P + N + E	83036	13096
32	200...250	2P + E	83042 <input checked="" type="checkbox"/>	11931
	380...415	3P + E	83046	19497
		3P + N + E	83047	14060
IP65				
16	200...250	2P + E	83081	9600
	380...415	3P + E	83085	13221
		3P + N + E	83086	13489
32	200...250	2P + E	83092	12582
	380...415	3P + N + E	83097	15107

Socket with Interlock Switch & DIN Rail Isoblock (4.5 modules)



82754

83796

- Switch designed for use in AC- 22A class applications
- Conforms to IEC 60309-1 & IEC 60309-2
- Provision to DIN mount 4.5 module device
- External impact strength: IK10
- Available in IP65 version
- Glow wire test: 850°C

[In] Rated Current (A)	[Ue] Rated Operational Voltage (V)	Poles Description	Reference	Unit MRP [₹]
16	200...250	2P + E	82754 <input checked="" type="checkbox"/>	11933
	380...415	3P + N + E	82759	17590
32	200...250	2P + E	83791 <input checked="" type="checkbox"/>	13489
	380...415	3P + N + E	83796	16070

Socket with Interlock Switch & DIN Rail Isoblock (6 modules)



82766

- Switch designed for use in AC- 22A class applications
- Conforms to IEC 60309-1 & IEC 60309-2
- Provision to DIN mount 6 module device
- External impact strength: IK10
- Available in IP65 version
- Glow wire test: 850°C

[In] Rated Current (A)	[Ue] Rated Operational Voltage (V)	Poles Description	Reference	Unit MRP [₹]
32	200...250	2P + E	82766	17966
63	380...415	3P + E	82782	24208
		3P + N + E	82783	24053

Please contact Customer Care Center for Stockable and Non stockable status of references.

*Bold references are MTO reference.

ELECTRA Metal Clad Plugs & Sockets are specially designed incorporating the latest safety, quality and user friendly features.

Construction

- The casting is made from non-corroding die-cast aluminum alloy combining exceptional compactness with high strength
- The design/construction eliminates the possibility of mismatch in fitting of plugs in corresponding sockets
- The floating contacts in the sockets are self-aligning and facilitates smooth plugging in without undue pressure (These can be easily removed for wiring)
- A provision for pilot pin facilitates mechanical interlocking in case of 63A ratings

Human Safety

Specially designed shroud to avoid accidental finger contact with plug-pins while inserting/removing the plug
Similarly, the contact tubes in sockets are deeply recessed to avoid human contact

- The earthing pins ensure that earth connection is made first and broken last, being longer than conducting pins
- The visible earth terminals facilitate easy checking of earth connection
- The cable grip to the plug is made very strong by providing a compression gland and by protecting it at the point of entry by a strong rubber guard

Applications

Industrial, Commercial & Domestic portable equipments like Hand/Power Tools, Industrial Ovens, Welding Sets, Mobile Generators, Furnaces, Ships, Office Machines, Refrigerators, Coolers, Air-Conditioners, Overhead Cranes, Chilling Cabinets, Tile Polishers and Sewing Machines

Plug



Rating (A)	Poles Description	Voltage (V)	MOQ	Reference	Unit MRP [₹]
10	2P	250	30	AP10 <input checked="" type="checkbox"/>	294
20	2P	250	30	AP20 <input checked="" type="checkbox"/>	310
20	3P	440	30	BP20 <input checked="" type="checkbox"/>	412
30	3P	440	20	BP30 <input checked="" type="checkbox"/>	750
63	3P+N+E	440	4	CP63 <input checked="" type="checkbox"/>	3391

Socket



Rating (A)	Poles Description	Voltage (V)	MOQ	Reference	Unit MRP [₹]
10	2P	250	30	AS10 <input checked="" type="checkbox"/>	310
20	2P	250	30	AS20 <input checked="" type="checkbox"/>	330
20	3P	440	30	BS20 <input checked="" type="checkbox"/>	463
30	3P	440	20	BS30 <input checked="" type="checkbox"/>	794
63	3P+N+E	440	4	CS63 <input checked="" type="checkbox"/>	3799

Please contact Customer Care Center for Stockable and Non stockable status of references.

*Bold references are MTO reference.

Complete range of switches & sockets suitable for both indoor & outdoor applications like Kitchens, Swimming Pools, Landscape Gardens, Exterior Walls and Other Environmentally Challenged Locations.



56SW116LE-GY



56SW216LE-GY



56SW332LE-GY

Description	IP Rating	Reference	Unit MRP [₹]
Surface Switches			
Single Pole Switches Less Enclosure			
1 Pole 250V 10A	IP66	56SW110LE-GY	4091
1 Pole 250V 16A	IP66	56SW116LE-GY	3796
1 Pole 250V 20A	IP66	56SW120LE-GY	5748
1 Pole 250V 32A	IP66	56SW132LE-GY	6854
Double Pole Switches Less Enclosure			
2 Pole 500V 16A	IP66	56SW216LE-GY	6622
2 Pole 500V 20A	IP66	56SW220LE-GY	6622
2 Pole 500V 32A	IP66	56SW232LE-GY	8787
2 Pole 500V 50A	IP66	56SW250LE-GY	10262
Triple Pole Switches Less Enclosure			
3 Pole 500V 10A	IP66	56SW310LE-GY	6125
3 Pole 500V 16A	IP66	56SW316LE-GY	6389
3 Pole 500V 20A	IP66	56SW320LE-GY	6726
3 Pole 500V 32A	IP66	56SW332LE-GY	7768
3 Pole 500V 50A	IP66	56SW350LE-GY	9048
3 Pole 500V 63A	IP66	56SW363LE-GY	10503
Four Pole Switches Less Enclosure			
4 Pole 500V 20A	IP66	56SW420LE-GY	8880



66CV563-RG



66P563-EO

Description	IP Rating	Reference	Unit MRP [₹]
IP66 Industrial Combination Switch Sockets with Enclosure			
Single Pole Switches Less Enclosure			
500V, 63A with 4 pole switch and 63A 5 Pin Socket	IP66	66CV563-RG	119035
Plug Top 5 Pin 500V 63A	IP66	66P563-EO	35728

Please contact Customer Care Center for Stockable and Non stockable status of references.
*Bold references are MTO reference.



56SO316RP-LE-GY-EX 56SO432LE-GY 56SO532LE-GY

Description	IP Rating	Reference	Unit MRP [₹]
Surface Socket Outlets			
3 Pin Sockets Less Enclosure			
3 Pin 250V 16A Indian Standard	IP66	56SO316RP-LE-GY-EX	3821
3 Pin 250V 20A Round Pin	IP66	56SO320LE-GY	5547
3 Pin 250V 32A Round Pin	IP66	56SO332LE-GY	6179
4 Pin Sockets Less Enclosure			
4 Pin 500V 20A Round Pin	IP66	56SO420LE-GY	8286
4 Pin 500V 32A Round Pin	IP66	56SO432LE-GY	9907
4 Pin 500V 50A Round Pin	IP66	56SO450LE-GY	15243
5 Pin Sockets Less Enclosure			
5 Pin 500V 10A Round Pin	IP66	56SO510LE-GY	8953
5 Pin 500V 20A Round Pin	IP66	56SO520LE-GY	8868
5 Pin 500V 32A Round Pin	IP66	56SO532LE-GY	10531
5 Pin 500V 40A Round Pin	IP66	56SO540LE-GY	15341
5 Pin 500V 50A Round Pin	IP66	56SO550LE-GY	15750

*Alternate reference 56SO440-GY (coming soon)



56PA420-EO 56PA532-EO 56CVI520-GY

Description	IP Rating	Reference	Unit MRP [₹]
Plugs			
3 Pin Angle Plugs			
3 pin 250V 16A Round Pin	IP66	56PA316RP-GY-EX	2874
3 Pin 250V 20A Round Pin	IP66	56PA320-EO	5748
3 Pin 250V 32A Round Pin	IP66	56PA332-EO	6640
4 Pin Angle Plugs			
4 Pin 500V 20A Round Pin	IP66	56PA420-EO	7072
4 Pin 500V 32A Round Pin	IP66	56PA432-EO	7362
4 Pin 500V 40A Round Pin	IP66	56PA440-EO	12244
4 Pin 500V 50A Round Pin	IP66	56PA450-EO	8735
5 Pin Angle Plugs			
5 Pin 500V 10A Round Pin	IP66	56PA510-EO	6951
5 Pin 500V 20A Round Pin	IP66	56PA520-EO	6951
5 Pin 500V 32A Round Pin	IP66	56PA532-EO	7954
5 Pin 500V 40A Round Pin	IP66	56PA540-EO	8493
5 Pin 500V 50A Round Pin	IP66	56PA550-EO	8695
Combination Switch Socket Outlet			
IP66 Interlocked Switch Socket with Enclosure			
4 Pin 500V 20A Round Pin	IP66	56CVI420-GY	30384
5 Pin 500V 20A Round Pin	IP66	56CVI520-GY	27488
5 Pin 500V 32A Round Pin	IP66	56CVI532-GY	27739

Please contact Customer Care Center for Stockable and Non stockable status of references.

*Bold references are MTO reference.

56 Series



56DB2-GY



56CB4N-GY

Description	IP Rating	Reference	Unit MRP ₹
Adaptable Enclosures with Gear Tray			
2 Gangpoints, 198X101X140mm	IP66	56DB2-GY	7584
Junction Boxes			
1 Gangpoint, 107X101X90mm	IP66	56JB1-GY	3300
2 Gangpoints, 204X101X90mm	IP66	56JB2-GY	5305
3 Gangpoints, 300X101X90mm	IP66	56JB3-GY	11367
4 Gangpoints, 204X198X90mm	IP66	56JB4-GY	10671

Description	Module Width	Reference	Unit MRP ₹
Switchgear Cover Assembly			
For 1,2,3 Pole MCB with 4 Pole RCD (max. 4M Width)	4	56CB4N-GY	6300



56FA2-GY



56E2-GY



56E1-GY



56E3-GY

Description	No. of Gangs	Reference	Unit MRP ₹
Flush Surrounds			
Flush Surround	2	56FA2-GY	3104
Flush Surround	3	56FA3-GY	4887
Mounting Enclosures (Back Boxes)			
101X101X63mm	1	56E1-GY	1337
198X101X63mm	2	56E2-GY	3430
294X101X63mm	3	56E3-GY	5497
198X198X63mm	4	56E4-GY	7072
294X198X63mm	6	56E6-GY	11307
391X198X63mm	8	56E8-GY	14835
391X391X63mm	16	56E16-GY	26880

Please contact Customer Care Center for Stockable and Non stockable status of references.
*Bold references are MTO reference.

SWITCH TO STYLE



Perfect solutions for the perfect you



LIVIA
Life. Style.

New



Miluz Lara



Clipsal X



Opale



Unica Pure



ZENcelo



Avatar On

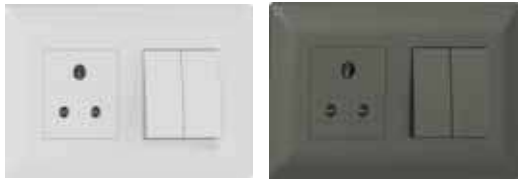

- **Sleek Design** - 2.7mm thin plate with curved body to minimize dust accumulation
- **Stylish Looks** - Soft white texture with glossy finish
- **Robust & Strong** - Innovative honeycomb designed grid plate for extra rigidity
- **Reliable** - High grade heat-resistant polycarbonate and laser marked wiring diagrams.
- **Easy to Install** - Snap-In / Snap-Out front loading modules and Bigger terminal holes
- **Green & Eco Friendly** - RoHS compliant range



Description	Reference for White	Unit MRP [₹]	Reference for Pristine Grey	Unit MRP [₹]
Switches				
10AX 1 way switch	P1001_N	142	P1001_PG_N	203
10AX 1 way switch with Indicator lamp	P1081	301	P1081_PG_N	397
10AX 2 way switch	P1002_N	237	P1002_PG_N	294
16AX 1 way switch	P1101_N	258	P1101_PG_N	317
16AX 1 way switch with Indicator lamp	P1181_N	360	P1181_PG_N	427
16AX 1 way switch (2M)	P1121_N	390	P1121_PG_N	502
16AX 2 way switch	P1102_N	349	P1102_PG_N	461
20A 1 way switch (1M) with indicator lamp	P11201_N	328	P11201_PG_N	376
20A DP switch with Indicator lamp	P1120_N	582	P1120_PG_N	759
32A DP switch with Indicator lamp	P1132_N	868	P1132_PG_N	1070
Bell Push				
10A Bell Push switch	P1005_N	265	P1005_PG_N	331
10A Bell Push switch (2M)	P1025_N	370	P1025_PG_N	440
10A bell push switch with Indicator	P1085_N	321	P1085_PG_N	425
10A bell push switch with Indicator (2M)	P1086_N	424	P1086_PG_N	538
Sockets				
6A 3Pin socket Outlet with shutter (BIS)	P2005NS_N	282	P2005NS_PG_N	347
10A/16A 3-pin Socket Outlet with Shutter	P2106_N	425	P2106_PG_N	514
Fan Regulators & Dimmers				
Step type fan regulator (1M)	P3100_N	835	P3100_PG_N	1015
Step type fan regulator (2M)	P3200_N	971	P3200_PG_N	1213
Dimmer 400W (1M)	P3004_N	1545	P3004_PG_N	2016
Dimmer 1000W (2M)	P3012	2337	P3012_PG_N	2562
USB Charger				
USB Charger	P7002_N	2022	P7002_PG_N	2350
Livia - A+C Type USB Charger (1M)	P7003_N	3044	P7003_PG_N	3664
Accessories				
RJ 11 Telephone outlet with shutter	P4011_N	239	P4011_PG_N	315
RJ 45 Cat 5e Data outlet with shutter	P4045_N	813	P4045_PG_N	975
RJ 45 Cat6 Data outlet with shutter	P4046_N	905	P4046_PG_N	1153
TV socket	P4500_N	229	P4500_PG_N	307
Blank off unit (1M)	P0001_N	63	P0001_PG_N	80
Foot Lamp with LED	P7001_N	982	P7001_PG_N	1170
Cord Outlet	P4550_N	256	P4550_PG_N	331
LED Phase Indicator	P5001_N	406	-	-
Mini MCB				
10A Mini MCB	P8010_N	570	P8010_PG_N	668
16A Mini MCB	P8016_N	570	P8016_PG_N	668
20A Mini MCB	P8020_N	570	P8020_PG_N	668
25A Mini MCB	P8025_N	570	P8025_PG_N	668
32A Mini MCB	P8032_N	570	P8032_PG_N	668

* Available till stocks lasts

Please contact Customer Care Center for Stockable and Non stockable status of references.

*Bold references are MTO reference.



P1186MS_N



P6002_N



P6004_N



P0703_N



P0704_N



P0706_PG_N

Description	Reference for White	Unit MRP [₹]	Reference for Pristine Grey	Unit MRP [₹]
Motor Starter Switch				
25A Motor Starter switch	P1186MS_N	1478	P1186MS_PG_N	1856
Hotel Series				
DND Switch	P6002_N	337	P6002_PG_N	365
MMR Switch	P6004_N	309	P6004_PG_N	365
DND & MMR Indicator	P6013	987	P6013_PG_N	1179
20A Key Card Switch - Electronic (3M)	P6005_N	5155	P6005_PG_N	6749

Description	Reference for White	Unit MRP [₹]	Reference for Pristine Grey	Unit MRP [₹]
Cover Plates				
1-2 M Grid & 1 M Cover Frame	P0701_N	162	P0701_PG_N	197
1-2 M Grid & 2 M Cover Frame	P0702_N	162	P0702_PG_N	200
3 M Grid & 3 M Cover Frame	P0703_N	204	P0703_PG_N	235
4 M Grid & 4 M Cover Frame	P0704_N	236	P0704_PG_N	292
6 M Grid & 6 M Cover Frame	P0706_N	302	P0706_PG_N	383
8 M Grid & 8 M Cover Frame - Horizontal	P0708_N	396	P0708_PG_N	480
8 M Grid & 8 M Cover Frame - Square	P0709_N	478	P0709_PG_N	583
9 M Grid & 9M Cover Frame	P07010_N	443	P07010_PG_N	604
12 M Grid & 12 M Cover Frame	P0712_N	579	P0712_PG_N	697
16 M Grid & 16M Cover Frame	P07016_N	689	P07016_PG_N	823
18 M Grid & 18 M Cover Frame	P0718_N	849	P0718_PG_N	1018

Please contact Customer Care Center for Stockable and Non stockable status of references.

*Bold references are MTO reference.



A fusion of beauty and functionality:

- Dew-drop-inspired design prevents dust and dirt accumulation.
- The 'volcanic' curve ensures ample room for wiring, for a seamless user experience.

Ideal for Mivan and modern construction methods:

- Seamlessly fits into newer (40 mm.) and conventional (50 mm.) metal boxes.

Durability and Safety:

- Prevents accidental shocks with no single-pin insertion in sockets.
- Durable copper contact for an enhanced life span (lasts up to 2 lakh clicks, or 30 years, at 15 clicks/day)

Effortless Installation:

- Clear markings for ideal wire strip length for accurate and safe installation
- Front-loading components and double-sided wire entry in sockets for greater ease.

Seamless Connectivity:

- Wiser™ is designed to optimize energy usage and is fully compatible with Miluz Lara switches and sockets.

Now Miluz Lara comes with the 10 years of warranty



MLSW161M1W_WH MLWSW1322MDP_AN

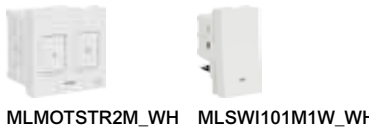

MLMOTSTR2M_WH MLWSW1101M1W_WH



MLBP1M_WH MLBPI2M_AN



MLSO62M3P_WH MLSO6162M3P_AN



MLDMR1M_WH MLFR5STP2M_AN



MLUSBA1M_WH MLUSBAC1M_AN



MLAQI2M_WH MLVSP1M_AN

Description	Reference for White	Unit MRP [₹]	Pack	Reference for Anthracite	Unit MRP [₹]	Pack
Switches						
10 A 1-way Switch (1M)	MLSW101M1W_WH	125	20	MLSW101M1W_AN	144	20
10 A 1-way Switch with Indicator (1M)	MLSWI101M1W_WH	295	20	MLSWI101M1W_AN	320	20
10 A 1-way Switch (2M)	MLSW102M1W_WH	320	10	MLSW102M1W_AN	346	10
10 A 1-way Switch with Indicator (2M)	MLSWI102M1W_WH	352	10	MLSWI102M1W_AN	400	10
10 A 2-way Switch (1M)	MLSW101M2W_WH	252	20	MLSW101M2W_AN	290	20
16 A 1-way Switch (1M)	MLSW161M1W_WH	270	20	MLSW161M1W_AN	311	20
16 A 1-way Switch with Indicator (1M)	MLSWI161M1W_WH	380	20	MLSWI161M1W_AN	437	20
16 A 1-way Switch (2M)	MLSW162M1W_WH	463	10	MLSW162M1W_AN	533	10
16 A 1-way Switch with Indicator (2M)	MLSWI162M1W_WH	500	10	MLSWI162M1W_AN	575	10
16 A 2-way Switch (1M)	MLSW161M2W_WH	407	20	MLSW161M2W_AN	480	20
20 A DP Switch with Indicator (2M)	MLSWI202MDP_WH	615	10	MLSWI202MDP_AN	800	10
32 A DP Switch with Indicator (2M)	MLSWI322MDP_WH	1012	10	MLSWI322MDP_AN	1160	10
Motor Starter Switch						
25 A Motor Starter Switch (2M)	MLMOTSTR2M_WH	1460	10	MLMOTSTR2M_AN	1679	10
Bell Push Switch						
6 A Bell Push (1M)	MLBP1M_WH	280	20	MLBP1M_AN	360	20
6 A Bell Push with Indicator (1M)	MLBPI1M_WH	340	20	MLBPI1M_AN	450	20
6 A Bell Push (2M)	MLBP2M_WH	395	10	MLBP2M_AN	525	10
6 A Bell Push with Indicator (2M)	MLBPI2M_WH	460	10	MLBPI2M_AN	570	10
Sockets						
6 A 3 Pin Socket with Shutter (2M)	MLSO62M3P_WH	250	10	MLSO62M3P_AN	288	10
6 A/16 A 3P Socket with Shutter (2M)	MLSO6162M3P_WH	400	10	MLSO6162M3P_AN	460	10
Fan Regulators and Dimmers						
4-Step Fan Regulator (1M)	MLFR4STP1M_WH	870	20	MLFR4STP1M_AN	1001	20
5-Step Fan Regulator (2M)	MLFR5STP2M_WH	1099	10	MLFR5STP2M_AN	1264	10
400 W Dimmer (1M)	MLDMR1M_WH*	1530	10	MLDMR1M_AN*	1760	10
USB Charger						
2.1 A USB Charger (1M)	MLUSBA1M_WH	2010	10	MLUSBA1M_AN	2200	10
1M 12 W Type A+C USB Charger (1M)	MLUSBAC1M_WH	3000	20	MLUSBAC1M_AN	3450	20
Air Quality Indicator						
Air Quality Indicator (2M)	MLAQI2M_WH*	-	-	MLAQI2M_AN*	-	-
Voltage Surge Protector						
Voltage Surge Protector 230 V (1M)	MLVSP1M_WH	2200	10	MLVSP1M_AN	2530	10

*Prices will be shared on request

Please contact Customer Care Center for Stockable and Non stockable status of references.

*Bold references are MTO reference.



MLDRCHM2M_WH



MLFTLMP2M_WH



MLTV1M_WH



MLRJ111M_AN



MLMM161P_WH



MLHDMI1M_AN



MLCP1M_WH



MLCP3MU_AN



MLCP4M_WH



MLCP8MH_WH

Description	Reference for White	Unit MRP [₹]	Pack	Reference for Anthracite	Unit MRP [₹]	Pack
Accessories						
TV Socket (1M)	MLTV1M_WH	238	10	MLTV1M_AN	310	10
RJ11 Tel. Outlet with Shutter (1M)	MLRJ111M_WH	248	10	MLRJ111M_AN	325	10
RJ45 Cat. 6 Data Outlet Shuttered (1M)	MLRJ451M_WH	900	10	MLRJ451M_AN	1100	10
Preterminated HDMI socket (1M)	MLHDMI1M_WH	1500	10	MLHDMI1M_AN	1725	10
LED Footlamp (2M)	MLFTLMP2M_WH	950	10	MLFTLMP2M_AN	1050	10
Door Chime (2M)	MLDRCHM2M_WH*	-	-	MLDRCHM2M_AN*	-	-
Blank Off Unit (1M)	MLBLANK1M_WH	62	20	MLBLANK1M_AN	80	20
Socket Adaptor (2M)	MLSA2M_NC	140	10	-	-	-
LED Phase Indicator (Red) (1M)	MLPHSIND1M_RD	400	10	-	-	-
MCB						
16A MCB SP 1M C curve	MLMM161P_WH	800	10	MLMM161P_AN	850	10
20A MCB SP 1M C curve	MLMM201P_WH	800	10	MLMM201P_AN	850	10
32A MCB SP 1M C curve	MLMM321P_WH	800	10	MLMM321P_AN	850	10
Cover Plates						
1M or 2M Grid and 1M Cover Frame	MLCP1M_WH	168	15	MLCP1M_AN	218	15
1M or 2M Grid and 2M Cover Frame	MLCP2M_WH	168	15	MLCP2M_AN	218	15
3M Grid and 3M Cover Frame	MLCP3M_WH	215	10	MLCP3M_AN	280	10
3M Uni Grid and 3M Cover Frame	MLCP3MU_WH	235	10	MLCP3MU_AN	306	10
4M Grid and 4M Cover Frame	MLCP4M_WH	248	8	MLCP4M_AN	322	8
6M Grid and 6M Cover Frame	MLCP6M_WH	312	5	MLCP6M_AN	406	5
8M Grid and 8M Cover Frame, Horizontal	MLCP8MH_WH	412	5	MLCP8MH_AN	536	5
8M Grid and 8M Cover Frame, Square	MLCP8MS_WH	541	5	MLCP8MS_AN	704	5
9M Cover Frame + 8M Grid	MLCP9M_WH	509	5	MLCP9M_AN	661	5
12M Grid and 12M Cover Frame	MLCP12M_WH	655	5	MLCP12M_AN	852	5
16M Cover Frame and Grid	MLCP16M_WH	780	5	MLCP16M_AN	1014	5
18M Grid and 18M Cover Frame	MLCP18M_WH	943	5	MLCP18M_AN	1226	5

*Coming Soon

Please contact Customer Care Center for Stockable and Non stockable status of references.

*Bold references are MTO reference.

Wiring Diagram Miluz Lara

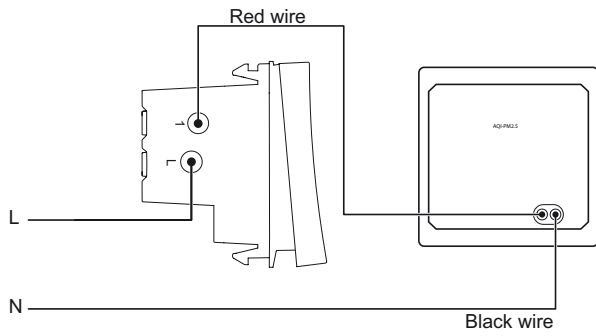

> Air Quality Indicator
MLAQI2M_WH, MLAQI2M_AN

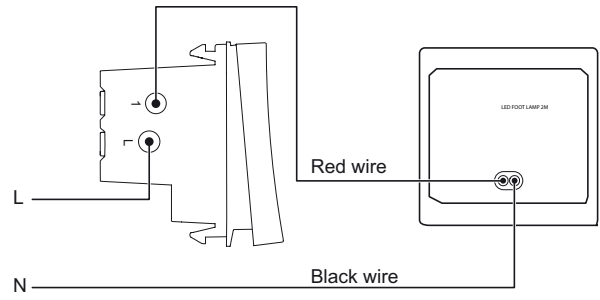

> LED Footlamp
MLFTLMP2M_WH, MLFTLMP2M_AN

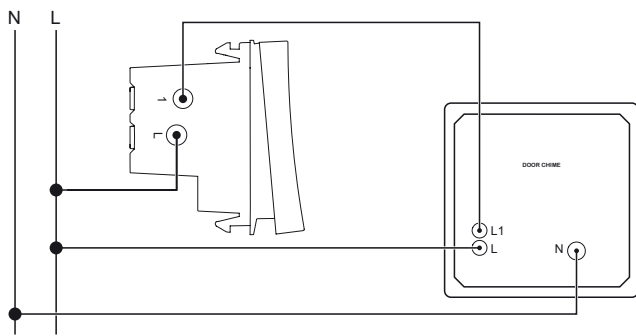

> Door Chime
MLDRCHM2M_WH, MLDRCHM2M_AN

12 W Type A+C USB Charger

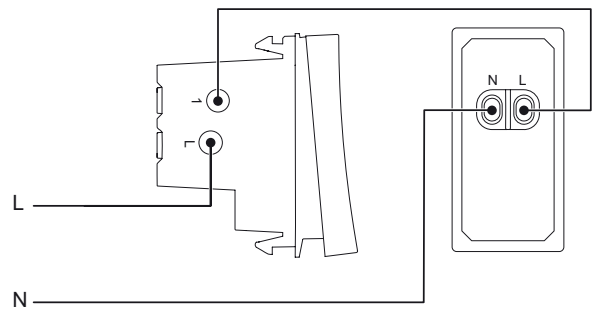

> USB Chargers
MLUSBAC1M_WH, MLUSBAC1M_AN

10 Years Warranty T&C

- Schneider Electric shall, at its sole discretion, repair or replace switches upto 16A (without LED indicator/lamp) and or 6A & 16A sockets in white color only if the Product is found to be having manufacturing defect (means defects solely as a result of faulty material and/or workmanship during manufacturing of Product) within 10 years from the date of manufacture of Product or from the date of invoice of Product, whichever is earlier.
- For all other wiring accessories, the warranty shall be 18 months starting from the date of delivery or 24 months from the date of manufacturing, whichever is earlier
- The warranty defines Schneider Electric's overall sole liability which does not include any other liability whatsoever including without limitation consequential losses or damages or re-installation costs arising from or in relation to the defective products.
- Schneider Electric reserves the right to change and/or improve the design of its Products without prior notice
- In any event whatsoever, if same Product with a similar design is not available, the Product will be replaced with an equivalent model available at that time at sole discretion of Schneider Electric.
- ***This warranty for the above products shall be rendered null & void in case of the following:***
 - a. If the original Schneider Electric mounting boxes have not been used to mount the plates & accessories.
 - b. If any attempt has been made to rectify, dismantle, tamper, or alter the product by any third party or by the customer himself.
 - c. If any damage resulting from the use of any cleaning chemicals on the Product which can adversely affect the product material (Like Acetone, Thinner, turpentine Oil etc.)
 - d. If the products are not installed as per the appropriate design specifications
- Warranty facilitations as per the standard process where customer to contact Customer Care Center (Email, Toll Free, chat) with relevant details & Log the complaint.

Clipsal X - As Stylish As Your World



Xtra STYLE

- Trendy Dual tone colour and finish
- Contemporary sloped design that blends seamlessly with the wall
- Vibrant and youthful colours and textured finishes that can stand out or blend in
- Textured finishes to match most Indian decors – Wood, Slate & Leather

Xtra STRONG

- Made to last for more than 1 Million Clicks
- 10A rated switches to enable Grouping – add as many loads as you want
- UV Stabilized to avoid decoloring

Xtra COMFORT

- Least noise level for unobstrusive switching
- Smooth finish which avoids light reflection off the surface
- Glossy Band making it Easy to Clean
- Large plate overhang to hide wall & paint imperfections



CPX101SW1M_ WE



CPX161SWL1M_ WE



CPX20DP2M_ WE



CPX6SK3PNS_ WE



CPXACUSB1P1M_ WE



CPX5STFAN2M_ WE



CPX21USB1P1M_ WE



CPXACUSB1P 1M_ WE



CPXTVCOAX1M_ WE



CPXKEYCARDSW_ WE



CPXDNDIN1M_ WE

Description	Reference for White	Unit MRP (₹)	Pack	Reference for Coke Grey	Unit MRP (₹)	Pack
Switches						
10AX 1 Way Switch	CPX101SW1M_WE	135	20	CPX101SW1M_GY	245	20
10A X1 Way Switch with Indicator	CPX101SWL1M_WE	333	20	CPX101SWL1M_GY	398	1
10AX 2 Way Switch	CPX102SW1M_WE	283	20	CPX102SW1M_GY	345	20
16AX 1 Way Switch	CPX161SW1M_WE	345	1	CPX161SW1M_GY	427	1
16AX 1 Way Switch with Indicator	CPX161SWL1M_WE	454	20	CPX161SWL1M_GY	539	20
16AX 1W Switch with Indicator (2M)	CPX161SWL2M_WE	558	1	-	-	-
20A DP Switch with Indicator (2M)	CPX20DP2M_WE	782	1	CPX20DP2M_GY	904	1
32A DP Switch with Indicator (2M)	CPX32DP2M_WE	1179	1	CPX32DP2M_GY*	1784	10
Motor Starter Switch						
25A Motor Starter Switch	CPXMTSTART2M_WE	1324	10	CPXMTSTART2M_GY	2452	10
Bell Press						
6A Bell Push	CPX6BP1M_WE	324	20	-	-	-
Sockets						
6A 3P Socket Outlet with Shutter (BIS Std.)	CPX6SK3PNS_WE	364	10	CPX6SK3PNS_GY	417	10
6A/16A 3P Socket with Shutter	CPX616SK_WE	551	10	CPX616SK_GY	629	10
Fan Regulators and Dimmers						
5-Step Fan Regulator (2M)	CPX5STFAN2M_WE	1225	1	CPX5STFAN2M_GY	1481	5
4-Step Fan Regulator (1M), White	CPX4STFRM1M_WE	1117	10	CPX4STFRM1M_GY	1350	10
USB Chargers						
2.1A USB Charger (1M)	CPX21USB1P1M_WE	2023	1	CPX21USB1P1M_GY	2389	1
2.4A A+C USB Charger (1M)	CPXACUSB1P1M_WE	3454	10	CPXACUSB1P1M_GY	3727	10
Accessories						
RJ11 Tel Outlet, No Shutter	CPXRJ11NS1M_WE	298	5	-	-	-
RJ11 Tel Outlet with Shutter	CPXRJ11_1M_WE	289	5	CPXRJ11_1M_GY	345	5
RJ45 Data Outlet with Shutter	CPXRJ451M_WE	987	12	CPXRJ451M_GY	1157	12
TV Socket	CPXTVCOAX1M_WE	271	5	CPXTVCOAX1M_GY	330	5
RJ45 Cover for Keystone Type	CPXRJ45KS1M_WE	338	5	-	-	-
Foot Light with LED	CPXFTLP2M_WE	1329	5	CPXFTLP2M_GY	1580	5
Buzzer	CPXBUZZ2M_WE	1324	2	CPXBUZZ2M_GY	1387	2
Blank Off Unit (1M)	CPXBLANK1M_WE	76	5	CPXBLANK1M_GY	102	5
Neon Phase Indicator						
Neon Phase Indicator (Red)	CPXPHASER1M	474	12	-	-	-
Hotel Series						
DND Indicator	CPXDNDIN1M_WE	737	12	-	-	-
16A Electronic Keycard Switch	CPXKEYCARDSW_WE	6409	1	CPXKEYCARDSW_GY	7231	1
Shaver Socket Horizontal	-	-	-	CPXSHAVER_GY	7965	1

Please contact Customer Care Center for Stockable and Non stockable status of references.

*Bold references are MTO reference.

Clipsal X - As Stylish As Your World



White



Coke Grey



Metallic Copper



Charcoal Black

Description	Reference for White	Unit MRP [₹]	Pack	Reference for Coke Grey	Unit MRP [₹]	Pack	Reference for Metallic Copper	Unit MRP [₹]	Pack	Reference for Charcoal Black	Unit MRP [₹]	Pack
Cover Plates												
1M or 2M Grid & 1M Cover Frame	CPXCP1M_WE	196	1	CPXCP1M_GY	336	10	CPXCP1M_MC	389	10	-	-	-
1M or 2M Grid & 2M Cover Frame	CPXCP2M_WE	212	10	CPXCP2M_GY	362	10	CPXCP2M_MC	422	10	CPXCP2M_CB	422	10
3M Grid & 3M Cover Frame	CPXCP3M_WE	243	10	CPXCP3M_GY	411	10	CPXCP3M_MC	483	10	CPXCP3M_CB	483	10
4M Grid & 4M Cover Frame	CPXCP4M_WE	287	1	CPXCP4M_GY	486	10	CPXCP4M_MC	568	10	-	-	-
6M Grid & 6M Cover Frame	CPXCP6M_WE	416	5	CPXCP6M_GY	706	5	CPXCP6M_MC	826	1	CPXCP6M_CB	826	1
8M Grid & 8M Cover Frame, Horizontal	CPXCP8ML_WE	515	1	CPXCP8ML_GY	875	5	CPXCP8ML_MC	1023	5	CPXCP8ML_CB	1023	5
8M Grid & 8M Cover Frame, Square	CPXCP8MSQ_WE	557	1	-	-	-	-	-	-	-	-	-
9M Cover Frame	CPXCP9M_WE	549	5	-	-	-	-	-	-	-	-	-
12M Grid & 12M Cover Frame	CPXCP12M_WE	629	1	CPXCP12M_GY	1269	1	-	-	-	-	-	-
18M Grid & 18M Cover Frame	CPXCP18M_WE	972	5	-	-	-	-	-	-	-	-	-



Sheesham

Description	Reference for Sheesham	Unit MRP (₹)	Pack
Cover Plates			
1M or 2M Grid & 1M Cover Frame	CPXCP1M_SH	616	10
1M or 2M Grid & 2M Cover Frame	CPXCP2M_SH	668	1
3M Grid & 3M Cover Frame	CPXCP3M_SH	762	10
4M Grid & 4M Cover Frame	CPXCP4M_SH	898	1
6M Grid & 6M Cover Frame	CPXCP6M_SH	1304	1
8M Grid & 8M Cover Frame, Horizontal	CPXCP8ML_SH	1617	5
12M Grid & 12M Cover Frame	CPXCP12M_SH	2242	5

Please contact Customer Care Center for Stockable and Non stockable status of references.
*Bold references are MTO reference.

Wiring Diagram Clipsal X

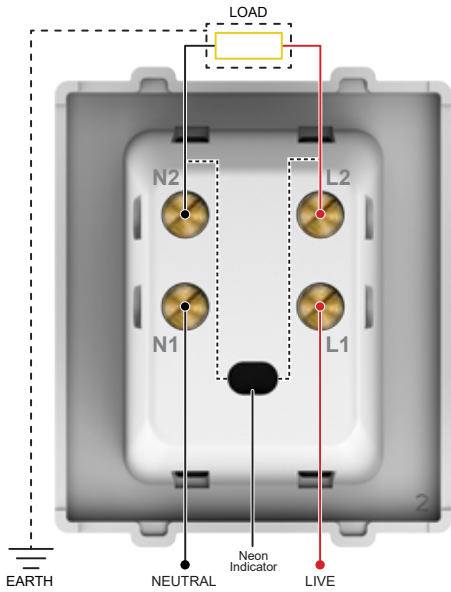

> 20A DP Switch with Indicator (2M)
CPX20DP2M_WE, CPX20DP2M_GY

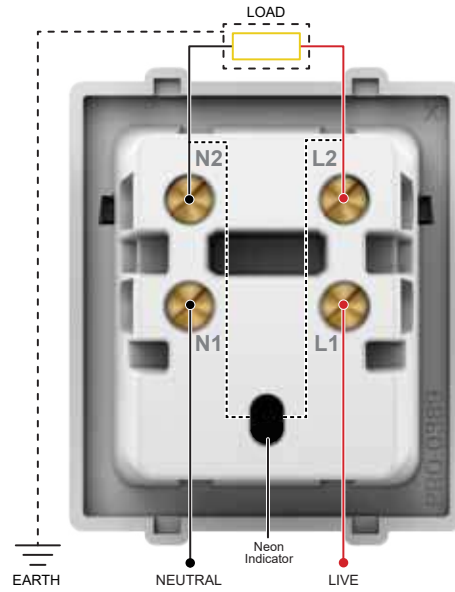

> 32A DP Switch with Indicator (2M)
CPX32DP2M_WE, CPX32DP2M_GY

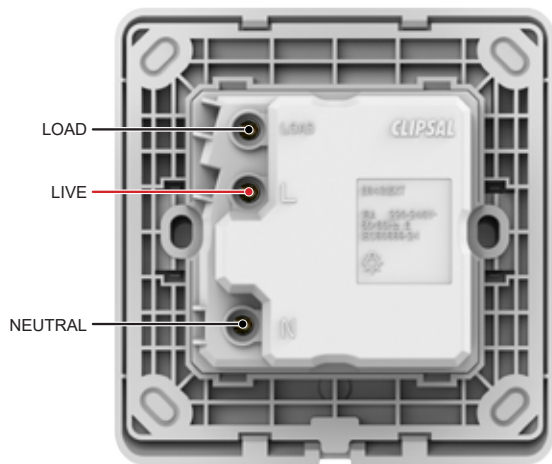

> 16A Electronic Keycard Switch
CPXKEYCARDSW_WE, CPXKEYCARDSW_GY

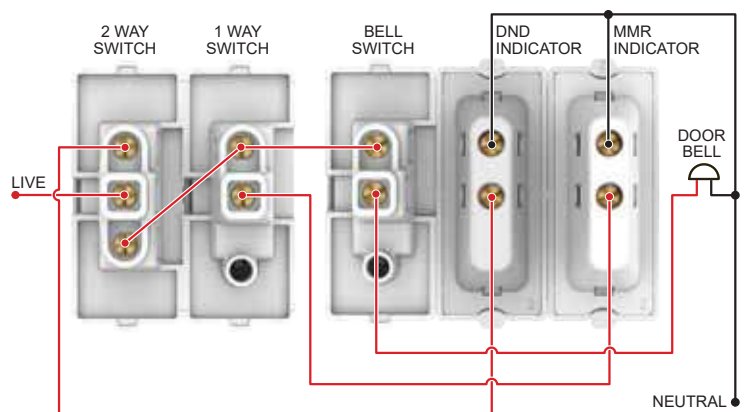

> MMR Switch > DND Indicator
CPXMMRSW1M_WE, CPXDNDIN1M_WE

Opale - Switches with Satin Finish



- **Patented Smooth Satin Finish** - Scratch Resistant, Easy to Clean & Prevents light reflection off surface
- **Safe to Use** - High grade flame retardant polycarbonate material & Child Proof sockets with unique shutter design
- **Hassle Free Operation** - 'Soft sound' switches with Gold plated Data Socket contacts for better connection
- **Easy to Install** - Snap-In / Snap-Out front loading modules and terminals with indented screws
- **Green & Eco Friendly** - RoHS compliant range



X1001WH



X1286WH



X1186WH



X1005WH



X1085WH



X2005WHNS



X2106WH



X3200WHCM



X3104WH



X7003WH



X5001

Description	Reference for White	Unit MRP [₹]	Pack	Reference for Coke Grey	Unit MRP [₹]	Pack
Switches						
6AX 1 way switch	X1001WH	246	20	AAKY1001	312	20
6AX 1 way switch with Indicator lamp	X1081WH	461	20	-	-	-
6AX 2 way switch	X1002WH	345	20	-	-	-
16AX 1 way switch	X1101WH	395	20	AAKY1101	499	20
16AX 1 way switch with Indicator lamp	X1181WH	564	20	AAKY1181	659	20
16AX 2 way switch	X1102WH	532	20	-	-	-
20A DP switch with Indicator (2M)	X1286WH	932	10	-	-	-
32A DP switch (2M)	AAKX1232	1375	10	-	-	-
Motor Starter Switch						
25A Motor Starter switch	X1186WH	2590	10	-	-	-
Bell Push						
6A Bell Push	X1005WH	386	20	-	-	-
6A Bell Push (2M)	X1025WH	552	10	-	-	-
6A Bell Push with Indicator	X1085WH	594	20	-	-	-
Sockets						
6A 3-Pin Socket Outlet with Shutter (BIS)	X2005WHNS	420	10	AAKY2005NS	507	10
6A/16A 3-Pin Socket Outlet with Shutter	X2106WH	648	10	AAKY2106	771	10
Fan Regulators & Dimmers						
Step Fan Regulator (1M)	X3100CMWH	1076	10	AAKY3100CM	1341	10
Step Type Fan Regulator (2M)	X3200WHCM	1464	5	AAKY3200CM	1837	5
Dimmer 400W (1M)	X3104WH	1356	10	-	-	-
Dimmer 400W (2M)	X3004WH	2110	5	-	-	-
USB Chargers						
2 Gang USB Charger - 2.1A (2M)	X7003WH	4006	15	-	-	-
Accessories						
RJ11 Telephone outlet with shutter	X4011WH	345	10	-	-	-
RJ45 Data Outlet with shutter	X4045WH	1188	20	-	-	-
TV Socket	X4500WH	323	10	-	-	-
RJ45 Cover for Key Stone Type	X4050WH	479	10	-	-	-
Buzzer	X3300WH	1577	2	-	-	-
Blank off unit (1M)	X0001WH	91	10	-	-	-
Neon Phase Indicator (Red)	X5001	559	20	-	-	-

Please contact Customer Care Center for Stockable and Non stockable status of references.
*Bold references are MTO reference.

Opale - Switches with Satin Finish



AAKX6006



AAKX6005

Description	Reference	Unit MRP [₹]	Pack
Hotel Series*			
Key Tag Switch (Mechanical Type 20 A)	AAKX6005	1957	1
Shaver Socket	AAKX6006	8636	1

*Available in white colour only



X0703



X0704



X0708

Description	Reference for White	Unit MRP [₹]	Pack	Reference for Coke Grey	Unit MRP [₹]	Pack
Cover Plates						
1-2 M Grid & 1 M Cover Frame	X0701	224	10	AAKY0801	295	10
1-2 M Grid & 2 M Cover Frame	X0702	237	10	-	-	-
3 M Grid & 3 M Cover Frame	X0703	280	10	AAKY0803	341	10
4 M Grid & 4 M Cover Frame	X0704	329	10	-	-	-
6 M Grid & 6 M Cover Frame	X0706	458	5	AAKY0806	548	5
8 M Grid & 8 M Cover Frame - Horizontal	X0708	596	5	-	-	-
8 M Grid & 8 M Cover Frame - Square	X0709	711	5	-	-	-
12 M Grid & 12 M Cover Frame	X0712	844	5	AAKY0812	1272	5
18 M Grid & 18 M Cover Frame	AAKX0718	1100	5	-	-	-

Please contact Customer Care Center for Stockable and Non stockable status of references.

*Bold references are MTO reference.

W.E.F. February 03rd, 2025

Unica Pure - Irresistibly Beautiful



Wood



Glass



Metal Rhodium Black



Sandy Beige

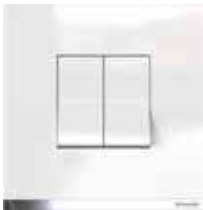

Polar White



Volcanic Grey



Pearl Black



Pewter Grey



Oak

Irresistibly Beautiful

- Authentic finishes - developed from the high quality natural material
- Ingenious Design - Demarcated dolly depicting clear on/off mode of the switch
- Modish Colors - perfectly gel with neutral, accent wall colors and blends perfectly with any decor

Irresistibly Safe & Sturdy

- Self Piercing Terminal - ensuring completely safe, robust and fast installation
- Facile & Guarded Technology - reduces tension in the switch rocker & increases the longevity of the switch
- Plated metal with Plastic over molded Gridplate - Robust, rigid & shock proof gridplate, ensuring durable installation on the metal box

Irresistibly Easy

- Key Hole Feature - Angular and linear adjustments of the gridplate can be easily achieved
- Revolutionary Ease of Mounting with Indicators & Markings

Irresistibly Sustainable

- Green Premium - Complies to HIGHEST INTERNATIONAL STANDARD of Green Certification for manufactured products (RoHS, REACH, PEP, EoLI) and is 100% Recyclable

Irresistibly Innovative

- Future Ready - Features of Voice & Mobile control to fit with smart homes

Irresistibly Versatile

- One Stop Shop - Extensive range covering residential, office, commercial or hospitality
- **Intermediate switches to control multiple 2way switches**

Unica Pure switches with six patented technologies



Life Guarded Sockets

Eliminate possibility of Single Pin Insertion making it extra safe for children

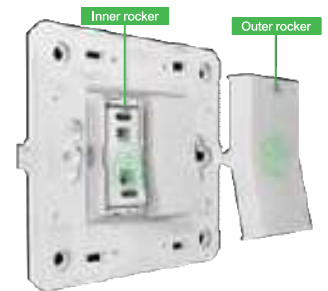

Facile & Guarded Technology

Reduces tension in the switch rocker & increases the longevity of the switch

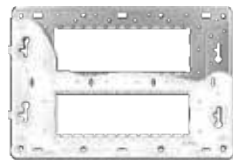

Key Hole Feature

Angular and linear adjustments of the gridplate can be easily achieved



Adjoining (V) Feature Technology

Ensuring perfect alignment of switches

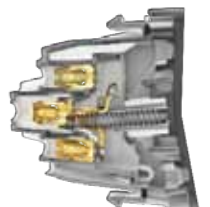

Self-piercing Terminal

Ensuring completely safe, robust and fast installation

Unica Pure - Irresistibly Beautiful



UNS61SW1M_WE



UNS161SWL1M_WE



UNS162MSWL1M_WE



UNS10SW1M_WE



UNS6SK3P2MNS_WE



UNS616SK2M_WE



UNS162SW2M_WE



UNSMTSTART2M_WE



UNS21USB2P2M_WE



UNS21USB1P1M_WE



UNS5STFAN2M_WE



UNSACUSB1P1M_WE



UNSHDMI_WE



UNSCPTVDIG1M_WE



UNSSKTLT2M_WE

Description	Reference for Polar White	Unit MRP	Pack	Reference for Volcanic Grey	Unit MRP	Pack
6A Switches						
6AX 1 Way Switch	UNS61SW1M_WE	227	20	UNS61SW1M_GY	261	20
6AX 1 Way Switch With Indicator	UNS61SWL1M_WE	402	20	UNS61SWL1M_GY	460	20
6AX 2 Way Switch	UNS62SW1M_WE	323	10	UNS62SW1M_GY	361	10
10A Intermediate Switches						
10AX Intermediate Switch	UNS10SW1M_WE	1446	1	UNS10SW1M_GY	1744	1
16AX Switches						
16AX 1 Way Switch	UNS161SW1M_WE	374	20	UNS161SW1M_GY	437	20
16AX 1 Way Switch With Indicator	UNS161SWL1M_WE	448	20	UNS161SWL1M_GY	521	20
16AX 2 Way Switch, Polar White	UNS162SW1M_WE	497	10	UNS162SW1M_GY	585	10
16A Master Switch, 2 Way, With Locator & Label	UNS162MSWL1M_WE	1156	20	UNS162MSWL1M_GY	1366	1
16Ax 2 Way 2M Switch	UNS162SW2M_WE	501	10	UNS162SW2M_GY	595	10
16AX~20A 1Way switch with Neon indicator	UNS201SWL1M_WE	440	10	UNS201SWL1M_GY	520	10
Double Pole Switches						
20A Double Pole Switch With Indicator	UNS20DP2M_WE	894	10	UNS20DP2M_GY	1053	1
32A Double Pole Switch With Indicator	UNS32DP2M_WE	1355	10	UNS32DP2M_GY	1623	10
Motor Starter Switch						
Motor Starter	UNSMTSTART2M_WE	2037	10	UNSMTSTART2M_GY	2410	10
Bell Switches						
6A Bellpress, 1M	UNS6BP1M_WE	333	20	UNS6BP1M_GY	391	20
6A Bellpress With Indicator, 1M	UNS6BPL1M_WE	461	20	UNS6BPL1M_GY	551	1
6A Bellpress, 2M, Polar White	UNS6BP2M_WE	458	10	UNS6BP2M_GY	539	1
6A Bellpress With Indicator, 2M	UNS6BPL2M_WE	565	10	UNS6BPL2M_GY	663	1
6A Sockets						
6A 3PIN Sockets outlet with Shutter (BIS)	UNS6SK3P2MNS_WE	476	10	UNS6SK3P2MNS_GY	524	10
6/16A Sockets						
6/16A Socket	UNS616SK2M_WE	557	10	UNS616SK2M_GY	692	10
USB Chargers						
2.1A 5V USB Charger, 2 Module	UNS21USB2P2M_WE	3410	10	UNS21USB2P2M_GY	4030	1
2.1A 5V USB Charger, 1 Module	UNS21USB1P1M_WE	2344	20	UNS21USB1P1M_GY	2780	20
2.4A 5V A+C USB Charger, 1 Module	UNSAUSB1P1M_WE	3610	10	UNSAUSB1P1M_GY	4060	10
Blank Plates						
Single Module Blank Plate	UNSBANK1M_WE	82	20	UNSBANK1M_GY	91	20
Fan Regulators						
4 Steps 360 Deg Fan Regulator, 1M	UNS4STFAN1M_WE	981	20	UNS4STFAN1M_GY	1136	20
5 Steps 360 Deg Fan Regulator, 2M	UNS5STFAN2M_WE	1554	10	UNS5STFAN2M_GY	1754	10
Emergency Light Indicator						
Emergency Light Module*	UNSEMERGENCY2M_WE	11536	1	-	-	-
Network, Connectivity & Media Series						
RJ 11 (WITH Shutter)	UNSRJ11_1M_WE	313	20	UNSRJ11_1M_GY	368	20
RJ 45 (WITH Shutter), Cat 6	UNSRJ45_1M_WE	1139	20	UNSRJ45_1M_GY	1319	20
TV Socket Coaxial	UNSTVCOAX1M_WE	328	20	UNSTVCOAX1M_GY	389	20
Volume Control	UNSVOLCTRL2M_WE	2583	10	UNSVOLCTRL2M_GY	3080	10
HDMI	UNSHDMI_WE	2204	20	UNSHDMI_GY	2486	20
TV Socket Digital (F-Connector)	UNSCPTVDIG1M_WE	372	1	-	-	-
PIR Motion Sensor*	UNSPIR_WE	10869	4	-	-	-
Skirt Light with LED, 2M	UNSSKTLT2M_WE	1449	10	UNSSKTLT2M_GY	1696	10
Door Chime 230V AC 2M	UNSIHIME2M_WE	1550	-	UNSIHIME2M_GY	1700	-

Please contact Customer Care Center for Stockable and Non stockable status of references.

*Bold references are MTO reference.

Unica Pure - Irresistibly Beautiful



UNSEKCSW_WE



UNSCURTAINSW2M_WE



UNSSHAVER_WE



UNSPIR_WE

Description	Reference for Polar White	Unit MRP ₹	Pack	Reference for Volcanic Grey	Unit MRP ₹	Pack
Hotel Series*						
Buzzer	UNSBUZZER1M_WE	2236	10	UNSBUZZER1M_GY	2451	10
Cord Outlet	UNSCORD1M_WE	428	20	UNSCORD1M_GY	476	20
DND / MMR Indicator*	UNSDM1M	1505	20	-	-	-
DND/MMR Indicator v.2	UNSDM1M_WE	1774		UNSDM1M_GY	2027	-
DND Switch	UNSDNDSW1M_WE	600	10	UNSDNDSW1M_GY	732	10
MMR Switch	UNSMRWSW1M_WE	600	10	UNSMRWSW1M_GY	732	10
SW DND MMR with interlock	UNSDNDMMRSW2M_WE	1000	10	UNSDNDMMRSW2M_GY	1200	10
Electronic Keycard Switch, White	UNSEKCSW_WE	7987	5	UNSEKCSW_GY	9232	5
Electronic Keycard Switch, Sandy Beige	UNSEKCSW_CL	8343	5	UNSEKCSW_CD	8231	5
Curtain Control Switch	UNSCURTAINSW2M_WE	1082	10	UNSCURTAINSW2M_GY	1255	10
Shaver Socket	UNSSHAVER_WE	8338	1	UNSSHAVER_GY	9093	1



UNSPHASEG1M



UNSPHASER1M

Description	Reference	Unit MRP ₹	Pack
LED Phase Indicator			
LED Phase Indicator, Red	UNSPHASER1M	533	20
LED Phase Indicator, Green	UNSPHASEG1M	533	20
LED Phase Indicator, Yellow	UNSPHASEY1M	533	20

Please contact Customer Care Center for Stockable and Non stockable status of references.
*Bold references are MTO reference.

Unica Pure - Irresistibly Beautiful



UNPGP2M



UNPGP6M

Description	Reference for Gridplate	Unit MRP [₹]	Pack
Cover Plates			
2 Module Gridplate (Fixing Frame) Only	UNPGP2M	181	4
3 Module Gridplate (Fixing Frame) Only	UNPGP3M	221	9
4 Module Gridplate (Fixing Frame) Only	UNPGP4M	255	8
6 Module Gridplate (Fixing Frame) Only	UNPGP6M	346	9
8 Module Gridplate (Fixing Frame) Only, Linear	UNPGP8ML	357	9
8 Module Gridplate (Fixing Frame) Only, Square	UNPGP8MSQ	457	6
12 Module Gridplate (Fixing Frame) Only	UNPGP12M	533	6



UNPSP2M_WD



UNPSP6M_WD

Description	Reference for Oak Wood	Unit MRP [₹]	Pack
Cover Plates			
1 Module Wood Cover Frame Only	UNPSP1M_WD	2577	6
2 Module Wood Cover Frame Only	UNPSP2M_WD	2739	6
3 Module Wood Cover Frame Only	UNPSP3M_WD	3390	6
4 Module Wood Cover Frame Only	UNPSP4M_WD	3923	6
6 Module Wood Cover Frame Only	UNPSP6M_WD	5598	3
8 Module Wood Cover Frame Only, Linear	UNPSP8ML_WD	6803	3
8 Module Wood Cover Frame Only, Square	UNPSP8MSQ_WD	8115	6
12 Module Wood Cover Frame Only	UNPSP12M_WD	10850	6



UNPSP2M_GW



UNPSP6M_GW



UNPSP2M_GB



UNPSP6M_GB

Description	Reference for Aqua Glass	Unit MRP [₹]	Pack	Reference for Pearl Black Glass	Unit MRP [₹]	Pack
Cover Plates						
1 Module Aqua Glass Cover Frame Only	UNPSP1M_GW	1425	6	UNPSP1M_GB	1687	6
2 Module Aqua Glass Cover Frame Only	UNPSP2M_GW	1603	6	UNPSP2M_GB	1897	6
3 Module Aqua Glass Cover Frame Only	UNPSP3M_GW	1805	6	UNPSP3M_GB	2063	6
4 Module Aqua Glass Cover Frame Only	UNPSP4M_GW	1886	6	UNPSP4M_GB	2236	6
6 Module Aqua Glass Cover Frame Only	UNPSP6M_GW	3407	3	UNPSP6M_GB	4019	3
8M Aqua Glass Cover Frame Only, Linear	UNPSP8ML_GW	3872	3	UNPSP8ML_GB	4561	3
8M Aqua Glass Cover Frame Only, Square	UNPSP8MSQ_GW	4904	6	UNPSP8MSQ_GB	5779	6
12 Module Aqua Glass Cover Frame Only	UNPSP12M_GW	6111	6	UNPSP12M_GB	7192	6

Please contact Customer Care Center for Stockable and Non stockable status of references.
*Bold references are MTO reference.

W.E.F. February 03rd, 2025

Unica Pure - Irresistibly Beautiful



UNPSP2M_ML



UNPSP6M_ML

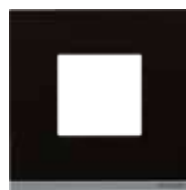

UNPSP2M_MD



UNPSP6M_MD

Description	Reference for Pewter Grey Metal	Unit MRP [₹]	Pack	Reference for Black Metal	Unit MRP [₹]	Pack
Cover Plates						
1 Module Pw Grey Metal Cover Frame Only	UNPSP1M_ML	2546	6	UNPSP1M_MD	2546	6
2 Module Pw Grey Metal Cover Frame Only	UNPSP2M_ML	2826	6	UNPSP2M_MD	2826	6
3 Module Pw Grey Metal Cover Frame Only	UNPSP3M_ML	3216	6	UNPSP3M_MD	3216	6
4 Module Pw Grey Metal Cover Frame Only	UNPSP4M_ML	3381	6	UNPSP4M_MD	3381	6
6 Module Pw Grey Metal Cover Frame Only	UNPSP6M_ML	5987	3	UNPSP6M_MD	5987	3
8Module Pw Grey Metal CF Only, Linear	UNPSP8ML_ML	6745	3	UNPSP8ML_MD	6745	3
8 Module Pw Grey Metal CF Only, Suare	UNPSP8MSQ_ML	8568	6	UNPSP8MSQ_MD	8568	6
12Module Pw Grey Metal Cover Frame Only	UNPSP12M_ML	10628	6	UNPSP12M_MD	10628	6

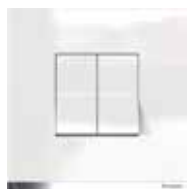

UNSCP2M_WE



UNSCP6M_WE



UNSCP2M_GY



UNSCP6M_GY



UNSCP2M_CD



UNSCP6M_CD

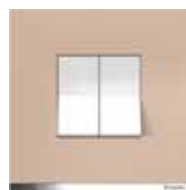

UNSCP2M_CL



UNSCP6M_CL

Description	Reference for Molded Polar White	Unit MRP [₹]	Pack	Reference for Molded Volcanic Grey	Unit MRP [₹]	Pack	Reference for Painted Mocha Brown	Unit MRP [₹]	Pack	Reference for Painted Sandy Biege	Unit MRP [₹]	Pack
Cover Plates												
1 Module Plastic Surround and Gridplate	UNSCP1M_WE	252	20	UNSCP1M_GY	358	20	UNSCP1M_CD	482	20	UNSCP1M_CL	491	20
2 Module Plastic Surround and Gridplate	UNSCP2M_WE	281	20	UNSCP2M_GY	401	20	UNSCP2M_CD	538	20	UNSCP2M_CL	557	20
3 Module Plastic Surround and Gridplate	UNSCP3M_WE	321	10	UNSCP3M_GY	457	10	UNSCP3M_CD	627	10	UNSCP3M_CL	625	10
4 Module Plastic Surround and Gridplate	UNSCP4M_WE	339	14	UNSCP4M_GY	488	14	UNSCP4M_CD	655	14	UNSCP4M_CL	655	14
6 Module Plastic Surround and Gridplate	UNSCP6M_WE	591	5	UNSCP6M_GY	843	5	UNSCP6M_CD	1128	5	UNSCP6M_CL	1167	5
8 Module Plastic Surround and Gridplate, Linear	UNSCP8ML_WE	665	5	UNSCP8ML_GY	941	5	UNSCP8ML_CD	1272	5	UNSCP8ML_CL	1296	5
8 Module Plastic Surround and Gridplate, Square	UNSCP8MSQ_WE	860	10	UNSCP8MSQ_GY	1304	10	UNSCP8MSQ_CD	1610	10	UNSCP8MSQ_CL	1610	5
9 Module Plastic Surround and Gridplate	UNSCP9M_WE	1080	5	UNSCP9M_GY	1686	5	-	-	-	-	-	
12 Module Plastic Surround and Gridplate	UNSCP12M_WE	1202	5	UNSCP12M_GY	2114	5	UNSCP12M_CD	2035	5	UNSCP12M_CL	2032	5
16 Module Plastic Surround and Gridplate	UNSCP16M_WE	1480	5	UNSCP16M_GY	2553	5	UNSCP16M_CD	2755	5	UNSCP16M_CL	2755	5
18 Module Plastic Surround and Gridplate	UNSCP18M_WE	1534	1	UNSCP18M_GY	2726	1	UNSCP18M_CD	2952	1	UNSCP18M_CL	2952	1

Please contact Customer Care Center for Stockable and Non stockable status of references.
*Bold references are MTO reference.

Wiring Diagram Unica Pure

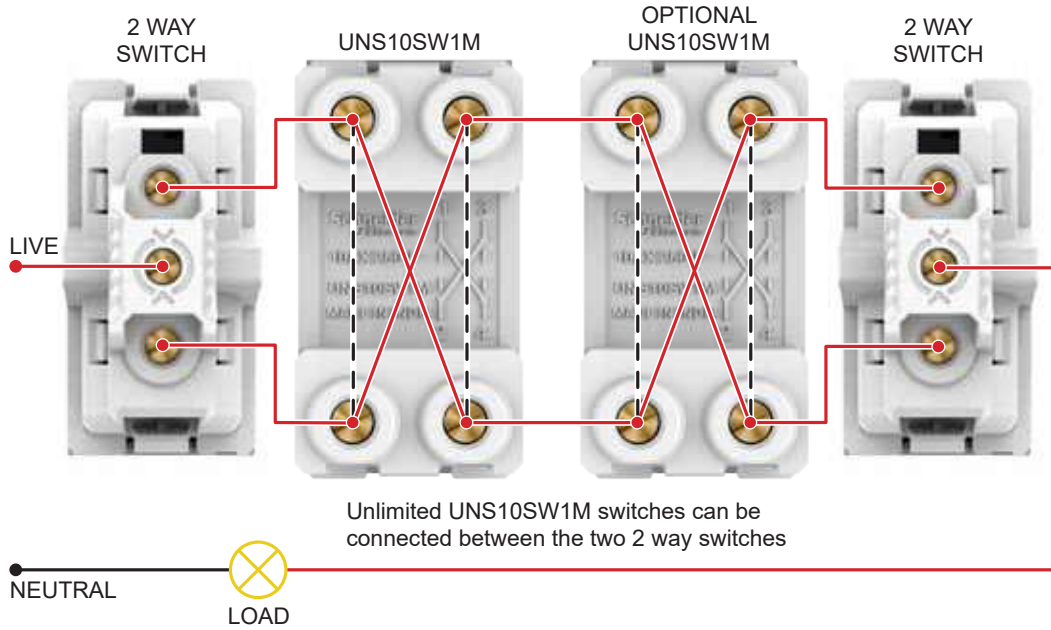

> 10AX Intermediate Switch

UNS10SW1M_WE, UNS10SW1M_GY

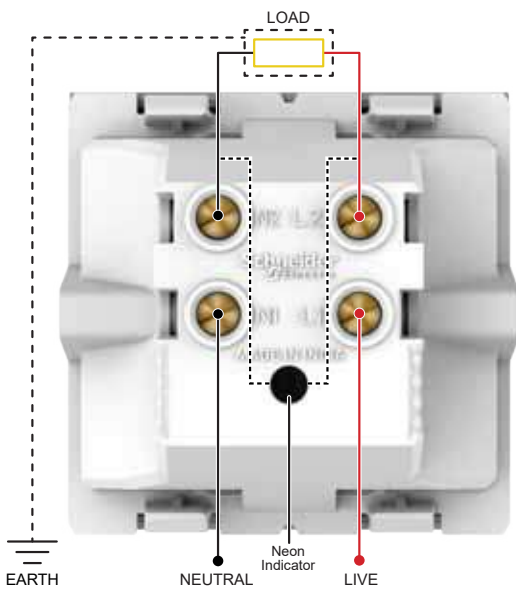

> 20A Double Pole Switch With Indicator

UNS20DP2M_WE, UNS20DP2M_GY

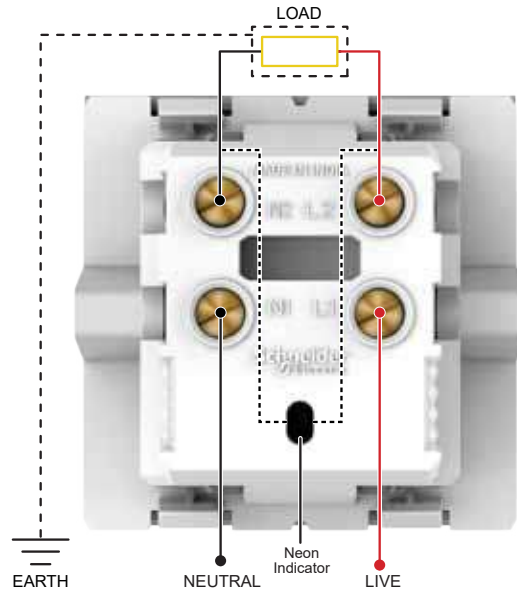

> 32A Double Pole Switch With Indicator

UNS32DP2M_WE, UNS32DP2M_GY

Wiring Diagram Unica Pure

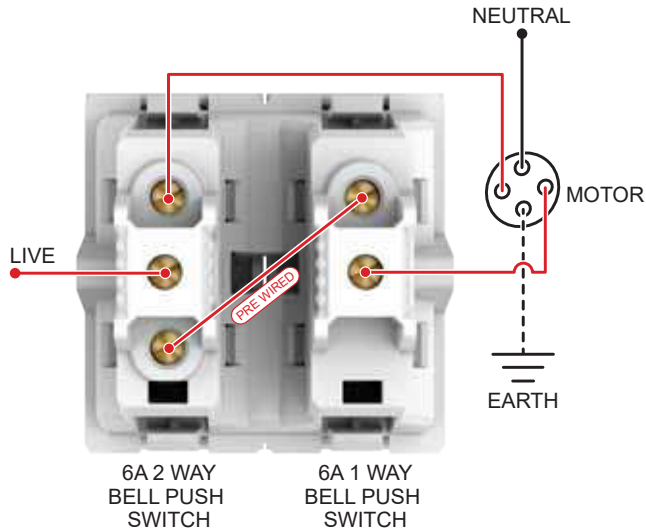

> Curtain Control Switch
UNSCURTAINSW2M_WE

1. Normal Operation

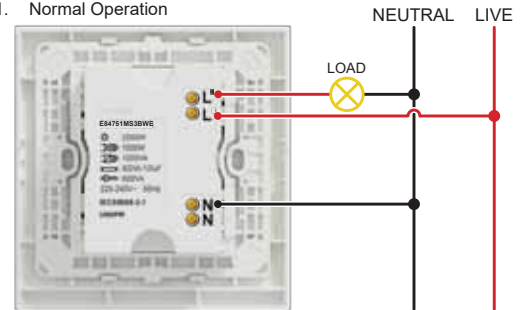

> PIR Motion Sensor*
UNSPIR_WE

2. Two sensors control one load

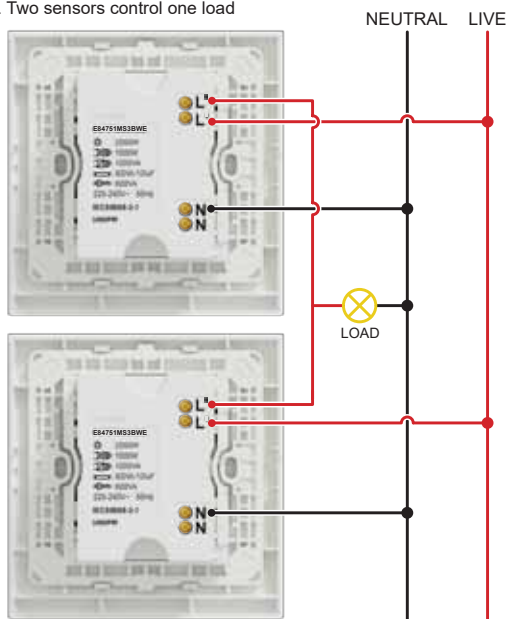

> PIR Motion Sensor*
UNSPIR_WE

3. One sensors control staircase timer (set time knob to 1s)

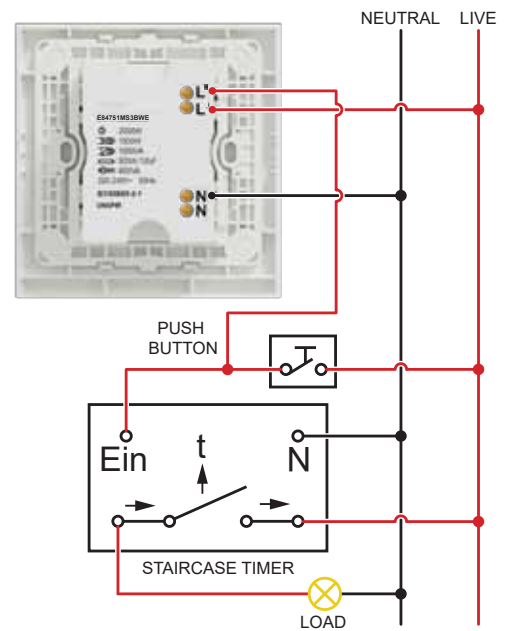

> PIR Motion Sensor*
UNSPIR_WE

Wiring Diagram Unica Pure

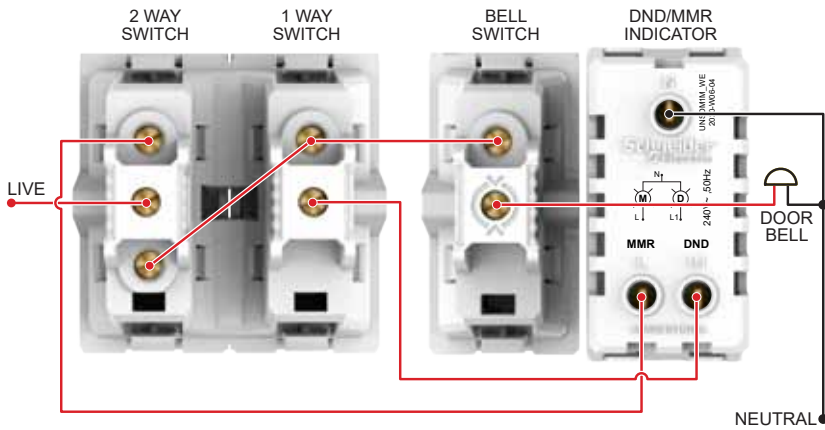

- > DND/MMR Indicator v.2
- > Do Not Disturb Switch
- > Make My Room Switch
- > DND Switch
- > MMR Switch

UNSDM1M_WE, UNSDM1M_GY, UNSDNDSW1M_WE,
UNSDNDSW1M_GY, UNSMMSW1M_WE, UNSMMSW1M_GY

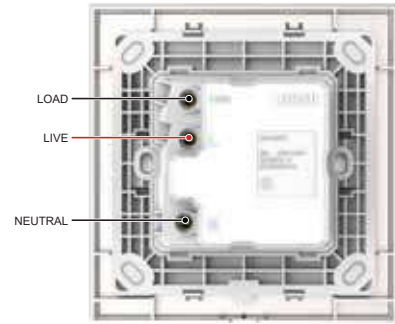

- > Unica Pure Key Card

UNSEKCSW_WE, UNSEKCSW_GY, UNSEKCSW_CL, UNSEKCSW_CD

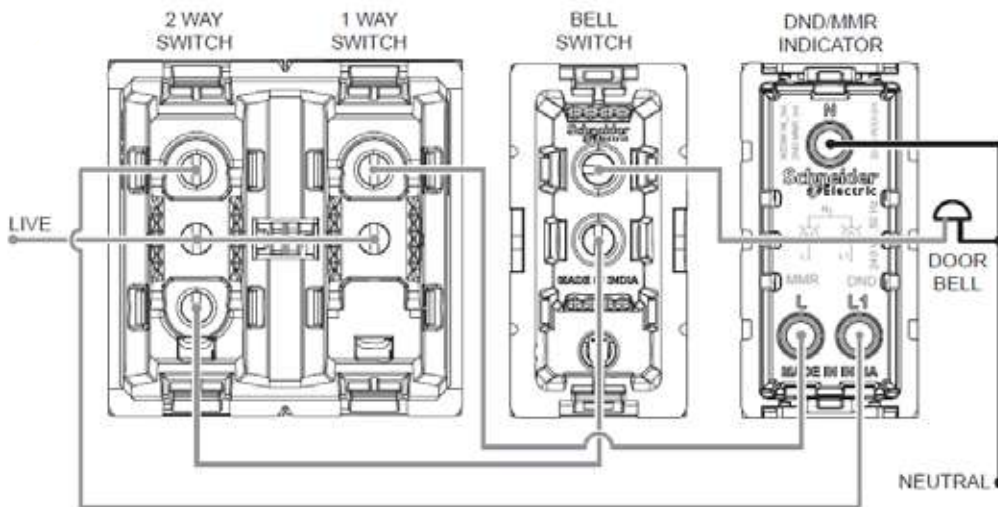

- > SW DNDMMR with interlock

UNSDNDMMRSW2M_WE & UNSDNDMMRSW2M_GY

ZENcelo India - The Revolutionary Full-Flat Switch



- **World's First and only Full-Flat Mechanical Switch**
- **Patented Iso-Motion Technology** - Ensures switch stays in the same position whether On or Off
- **Robust & Strong** - Made of corrosion-resistant, heat-resistant and impact-resistant polycarbonate
- **Safe to Use** - Electric arc encapsulated switches and Data Sockets with patented integrated shutter
- **Designed to Last** - Switches tested to 80,000 times; Sockets tested to 15,000 cycles.
- **Green & Eco Friendly** - RoHS compliant range
- **Dust Proof Cover**
- **All Dark Grey references covered with electrostatic protective film**
- **Intermediate switches to control multiple 2way switches**
- **16AX~20A 1 Way 2G Switch (1M) - IN8444/16: Single switch to control two loads**



Description	Reference for White	Unit MRP [₹]	Pack	Reference for Dark Grey	Unit MRP [₹]	Pack
Switches						
6AX 1 Way switch	IN8401	424	10	IN8401(BZ)	531	10
6AX 1 Way switch (2M)	IN8421	761	10	IN8421(BZ)	901	10
6AX 2 Way switch	IN8402	531	10	IN8402(BZ)	638	10
6AX 1 Way switch with Neon	IN8481	681	10	IN8481(BZ)	815	10
16AX~20A 1 Way switch	IN8401/16	647	10	IN8401/16(BZ)	788	10
16AX~20A 1 Way switch (2M)	IN8421/16	1006	10	-	-	-
16AX~20A 1 Way switch with Neon	IN8481/16	929	10	IN8481/16(BZ)	1100	10
16AX~20A 1 Way switch with Neon (2M)	IN8482/16	1189	10	IN8482/16(BZ)	1413	10
16AX~20A 2 Way switch	IN8402/16	919	10	IN8402/16(BZ)	1191	10
16AX~20A 2 Way switch (2M)	IN8422/16	1100	10	IN8422/16(BZ)	1419	10
16AX~20A 1 Way 2G switch (1M)	IN8444/16	1058	10	IN8444/16(BZ)	1288	10
10AX Intermediate switch	IN8430/IM	1692	10	IN8430/IM(BZ)	1912	1
6A Momentary Switch	IN8487	836	10	IN8487_BZ	987	-
20A DP Switch with Neon (2M)	IN8486/20	1417	5	IN8486/20(BZ)	1855	5
32A DP Switch with Neon (2M)	IN8486/32	2205	5	IN8486/32(BZ)	2649	5
Motor Starter Switch						
25A Motor Starter switch (2M)	IN8425MS	3627	10	IN8425MS(BZ)	3877	10
Bell Push						
6A Bell Push switch	IN8405	602	10	IN8405(BZ)	730	10
6A Bell Push switch (2M)	IN8425	978	10	IN8425(BZ)	1164	10
6A Bell Push switch with Neon	IN8485	884	10	IN8485(BZ)	1042	10
6A Bell Push switch with Neon (2M)	IN8486	1034	10	IN8486(BZ)	1281	10
Sockets						
6A 3 PIN Socket Outlet with Shutter (BIS)	IN8426UNS	700	10	IN8426UNS_BZ	847	10
6A/16A 3 Pin Socket with Shutter	IN8426/16	1042	10	IN8426/16(BZ)	1276	10
Fan Regulators & Dimmers						
Fan Control (5 Speeds)	IN84SFR	2501	5	IN84SFR(BZ)	3001	5
Full Flat 500W Dimmer Module (1 Gang)	IN8404D	2272	10	IN8404D(BZ)	2691	10
USB Chargers						
1 Gang USB Charger - 2.1A (1M)	IN8431USB_WE	4036	10	IN8431USB_BZ	4630	10
2.4A 5V A+C USB Charger (1M)	IN8431ACUSB_WE	4461	10	IN8431ACUSB_BZ	5113	10
Accessories						
RJ11 Telephone Outlet with shutter (1 Gang)	IN8431RJS4	676	10	IN8431RJS4(BZ)	833	10
RJ45 Cat6 Data Outlet with shutter	IN8431RJ6	2388	10	IN8431RJ6(BZ)	2917	10
TV Socket	IN8431TV	516	10	IN8431TV(BZ)	653	10
Foot Lamp with White LED (2M)	IN8490FLW	4816	10	-	-	-
Foot Lamp with Yellow LED (2M)	IN8490FLY	4696	10	-	-	-
Blank off unit (1M)	IN8430X	158	10	IN8430X(BZ)	194	10
Door Chime 230VAC 2M	INCHIME8488	2325	-	INCHIME8488_BZ	2600	-
Hotel Series						
Do Not Disturb Panel	INH8451	3587	10	INH8451(BZ)	4055	10
Make My Room Panel	INH8454	3353	10	INH8454(BZ)	3742	10
Do Not Disturb Switch	INH8452	1781	10	INH8452(BZ)	1966	10
Do Not Disturb Switch (2M)	-	-	-	INH8453(BZ)	2204	10
Make My Room Switch	INH8455	1740	10	INH8455(BZ)	2072	10
SW DND MMR White with interlock 2M	INH8456_WE	3050	10	INH8456_BZ	3350	10

Please contact Customer Care Center for Stockable and Non stockable status of references.
*Bold references are MTO reference.

ZENcelo India - The Revolutionary Full-Flat Switch



E8431EKT-OS



E84T727V>SZ-OS

Description	Reference for White	Unit MRP [₹]	Pack	Reference For Silver Bronze	Unit MRP [₹]	Pack
Hotel Series						
16A Electronic Key Card Time Delay Switch	E8431EKT-OS	14113		E8431EKT>SZ-OS	17643	1
Universal Shaver Unit, Vertical	-	-		E84T727V>SZ-OS	9946	1
Universal Shaver Unit, Horizontal	-	-		E84T727H>SZ-OS	9946	1



IN8403C

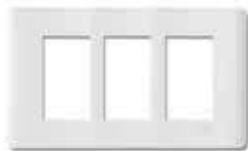

IN8406C



IN8402C(BZ)

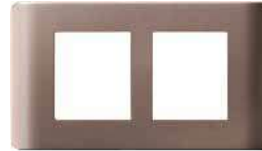

IN8404C(SZ)



IN84012C(SA)

Description	Reference for White	Unit MRP [₹]	Pack	Reference for Dark Grey	Unit MRP [₹]	Pack	Reference for Silver Bronze	Unit MRP [₹]	Pack	Reference for Satin Silver	Unit MRP [₹]	Pack
Cover Plates												
1M Grid & 1M Cover Frame	IN8401C	402	10	IN8401C(BZ)	482	10	IN8401C(SZ)	1132	10	IN8401C(SA)	1242	10
2M Grid & 2M Cover Frame	IN8402C	421	10	IN8402C(BZ)	505	10	IN8402C(SZ)	1120	10	IN8402C(SA)	1229	10
3M Grid & 3M Cover Frame	IN8403C	496	10	IN8403C(BZ)	596	10	IN8403C(SZ)	1377	10	IN8403C(SA)	1510	10
4M Grid & 4M Cover Frame	IN8404C	541	10	IN8404C(BZ)	700	10	IN8404C(SZ)	1654	10	IN8404C(SA)	1816	10
6M Grid & 6M Cover Frame	IN8406C	825	5	IN8406C(BZ)	994	5	IN8406C(SZ)	2272	5	IN8406C(SA)	2516	5
8M Grid & 8M Cover Frame - Horizontal	IN8408HC	990	5	IN8408HC(BZ)	1189	5	IN8408HC(SZ)	3098	5	IN8408HC(SA)	3400	5
8M Grid & 8M Cover Frame - Square	IN8408SC	1320	5	IN8408SC(BZ)	1833	5	IN8408SC(SZ)	3763	5	IN8408SC(SA)	4128	5
9M Grid & 9M Cover Frame	IN8409C	1817	5	IN8409C(BZ)	2282	5	IN8409C(SZ)	5201	5	-	-	-
12M Grid & 12M Cover Frame	IN84012C	2190	5	IN84012C(BZ)	2707	5	IN84012C(SZ)	6994	5	IN84012C(SA)	7676	5
18M Grid & 18M Cover Frame	IN84018C	3089	5	IN84018C(BZ)	4007	5	IN84018C(SZ)	9258	5	IN84018C(SA)	10161	5

Please contact Customer Care Center for Stockable and Non stockable status of references.
*Bold references are MTO reference.

W.E.F. February 03rd, 2025

Wiring Diagram ZENcelo

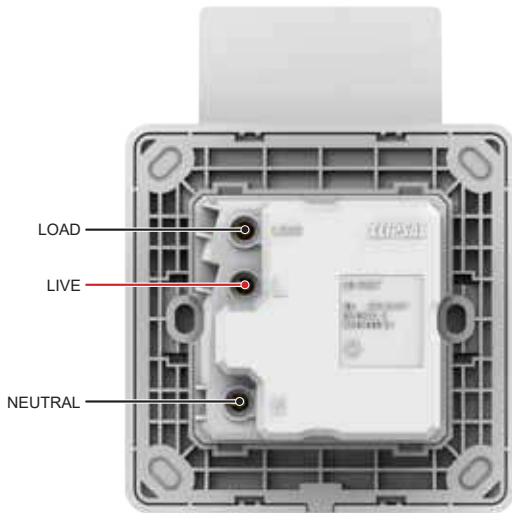

> **16A Electronic Key Card Time Delay**
E8431EKT-OS, E8431EKT>SZ-OS

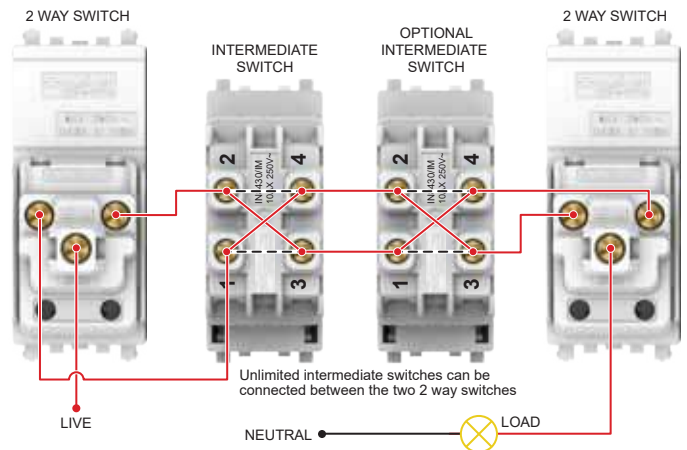

> **10AX Intermediate Switch**
IN8430/IM, IN8430/IM (BZ)

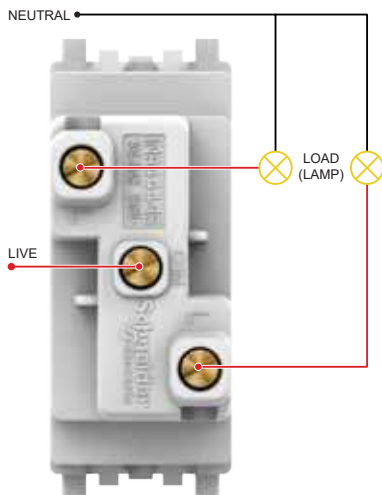

> **16AX~20A 1 Way 2G Switch (1M)**
IN8444/16, IN8444/16 (BZ)

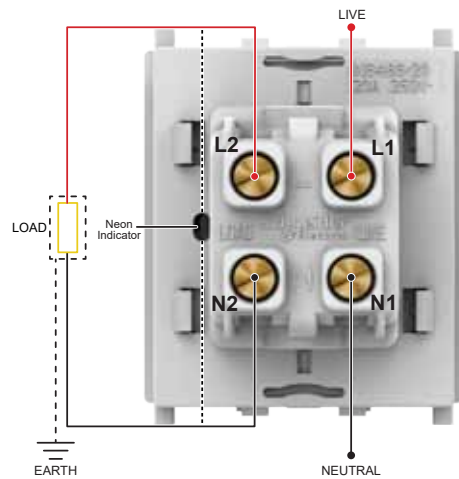

> **20A DP Switch with Neon (2M)**
IN8486/20, IN8486/20 (BZ)

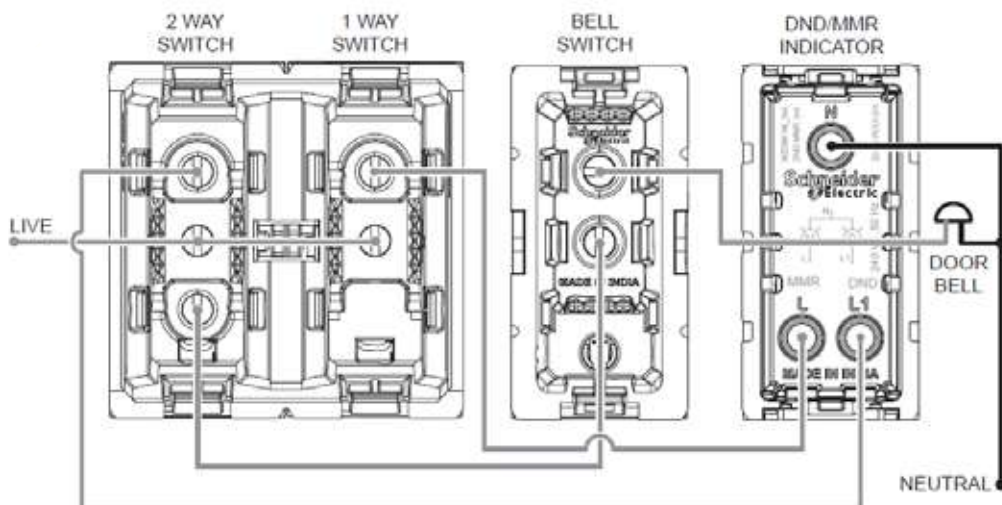

> **SW DNDMMR White with interlock 2M**
INH8456_WE & INH8456_BZ

Wiring Diagram ZENcelo

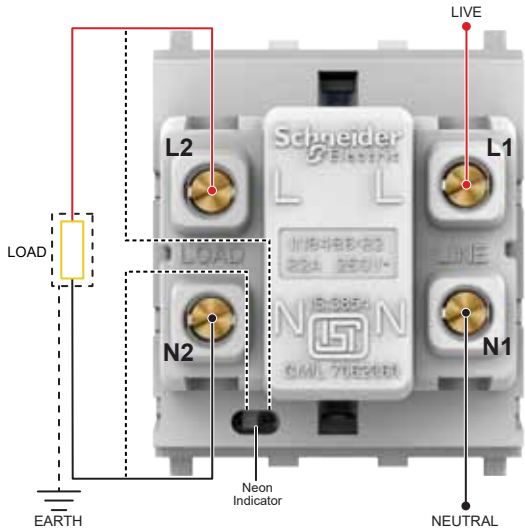

> 32A DP Switch with Neon (2M)

IN8486/32, IN8486/32 (BZ)

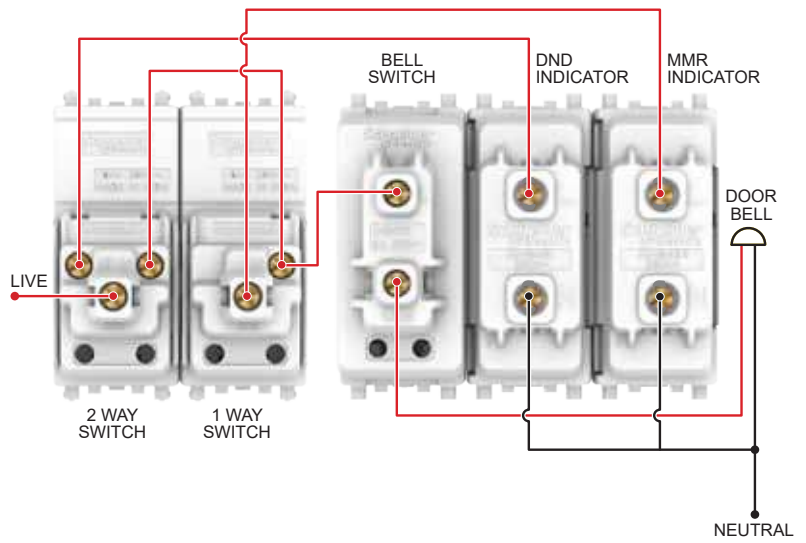

> Do Not Disturb Panel > Make My Room Panel
> Do Not Distrub Switch > Make My Room Switch

INH8451, INH8451 (BZ), INH8454, INH8454 (BZ),
INH8452, INH8452 (BZ), INH8455, INH8455 (BZ)

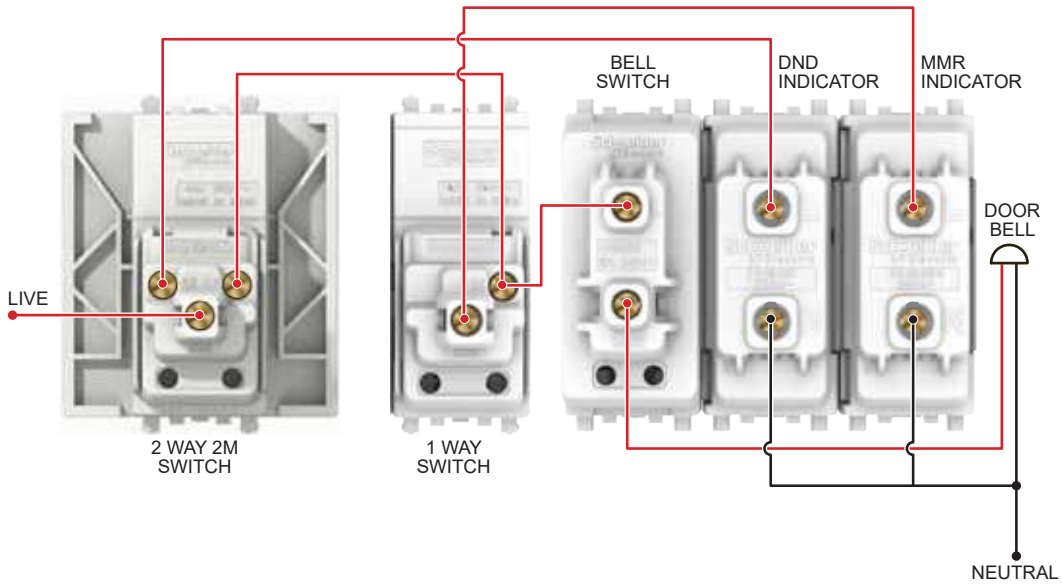

> Do Not Disturb Panel > Make My Room Panel
> Do Not Disturb Switch (2M) > Make My Room Switch

INH8451, INH8451 (BZ), INH8454, INH8454 (BZ)
INH8453 (BZ), INH8455, INH8455 (BZ)

AvatarOn - It's also a Switch



White (WE)



Wine Gold (WG)



Dark Grey (DG)



Dark Wood (WD)



Gold Hairline (GH)



Light Wood (LW)



Award-winning Designs: In 2017, AvatarOn gained international recognition for its innovative design and quality excellence and was awarded the iF Design Award

Ingenious Beauty

- The ground-breaking AvatarOn series is a true marriage of aesthetics and practicality, making it a perfect choice for all home or office designs.

Safe and Reliable

- Our patented "Slim Rocker, Sure Click" SS technology not only gives AvatarOn a greater thinness overall, but also a near-zero contact jitter that reduces sparks, thus ensuring a safe and reliable use.

Customisable Covers for True Adaptability

- AvatarOn switches are available in an array of replaceable covers for full customisation and integration into any home decor. The customised pattern covers of AvatarOn provides you with an extra canvas to showcase your creativity in a subtle yet apparent way.

Modern Look

- The stylish and streamlined design of AvatarOn switch covers are finished in white, soft wood, dark wood and gold hairline materials for a classic look and universal elegance.

Tech-chic Design that Shines

- The AvatarOn soft LED locators merges seamlessly with its sleek giant dolly, creating a stylish and streamlined design and glow with a soft luminescent in the dark, indicating the exact location of each switch at night.





Multifunctional Accessories for Every Day Conveniences

Product Description	Color	Product Ref. No.	Unit MRP [₹]	Pack
16A Switches (Base + Cover Plate)				
16AX 250V 1 Gang 1 Way Switch	White	E8331L1_WE_G8	609	1
	Wine Gold	E8331L1_WG_G8	915	10
	Dark Grey	E8331L1_DG_G8	915	1
	Metal Gold Hairline	E8331L1_GH_G8	919	10
	Light Wood	E8331L1_LW_G8	990	10
	Dark Wood	E8331L1_WD_G8	919	10
16AX 250V 1 Gang 1 Way Switch with LED Indicator	White	E8331L1LED_WE_G8	915	1
	Wine Gold	E8331L1LED_WG_G8	1368	10
	Dark Grey	E8331L1LED_DG_G8	1368	1
	Metal Gold Hairline	E8331L1LED_GH_G8	1375	10
	Light Wood	E8331L1LED_LW_G8	1616	10
	Dark Wood	E8331L1LED_WD_G8	1375	10
16AX 250V 1 Gang 2 Way Switch	White	E8331L2_WE_G8	629	1
	Wine Gold	E8331L2_WG_G8	976	10
	Dark Grey	E8331L2_DG_G8	976	1
	Metal Gold Hairline	E8331L2_GH_G8	981	10
	Light Wood	E8331L2_LW_G8	1057	10
	Dark Wood	E8331L2_WD_G8	981	10
16AX 250V 1 Gang 2 Way Switch with LED Indicator	White	E8331L2LED_WE_G8	976	10
	Wine Gold	E8331L2LED_WG_G8	1466	10
	Dark Grey	E8331L2LED_DG_G8	1466	1
	Metal Gold Hairline	E8331L2LED_GH_G8	1473	10
	Light Wood	E8331L2LED_LW_G8	1731	10
	Dark Wood	E8331L2LED_WD_G8	1667	10
16AX 250V 2 Gang 1 Way Switch	White	E8332L1_WE_G8	949	1
	Wine Gold	E8332L1_WG_G8	1425	10
	Dark Grey	E8332L1_DG_G8	1425	1
	Metal Gold Hairline	E8332L1_GH_G8	1439	10
	Light Wood	E8332L1_LW_G8	1500	10
	Dark Wood	E8332L1_WD_G8	1439	10
16AX 250V 2 Gang 1 Way Switch with LED Indicator	White	E8332L1LED_WE_G8	1425	1
	Wine Gold	E8332L1LED_WG_G8	2139	10
	Dark Grey	E8332L1LED_DG_G8	2139	1
	Metal Gold Hairline	E8332L1LED_GH_G8	2160	10
	Light Wood	E8332L1LED_LW_G8	2549	10
	Dark Wood	E8332L1LED_WD_G8	2160	10
16AX 250V 2 Gang 2 Way Switch	White	E8332L2_WE_G8	1156	1
	Wine Gold	E8332L2_WG_G8	1734	10
	Dark Grey	E8332L2_DG_G8	1734	1
	Metal Gold Hairline	E8332L2_GH_G8	1750	10
	Light Wood	E8332L2_LW_G8	2066	10
	Dark Wood	E8332L2_WD_G8	1750	10

Please contact Customer Care Center for Stockable and Non stockable status of references.

*Bold references are MTO reference.

AvatarOn - It's also a Switch

		Product Description	Color	Product Ref. No.	Unit MRP ₹	Pack
16A Switches (Base + Cover Plate)						
	E8332L2LED_WE_G8	16AX 250V 2 Gang 2 Way Switch with LED Indicator	White	E8332L2LED_WE_G8	1734	10
			Wine Gold	E8332L2LED_WG_G8	2602	10
			Dark Grey	E8332L2LED_DG_G8	2602	1
			Dark Wood	E8332L2LED_WD_G8	2627	10
	E8332L2LED_WD_G8		White	E8333L1_WE_G8	1566	1
			Wine Gold	E8333L1_WG_G8	2350	10
			Dark Grey	E8333L1_DG_G8	2394	1
			Metal Gold Hairline	E8333L1_GH_G8	2383	10
	E8333L1LED_WE_G8	16AX 250V 3 gang 1 Way Switch	Light Wood	E8333L1_LW_G8	2462	10
			Dark Wood	E8333L1_WD_G8	2383	10
			White	E8333L1LED_WE_G8	2350	10
			Wine Gold	E8333L1LED_WG_G8	3523	10
	E8333L1LED_WD_G8		Dark Grey	E8333L1LED_DG_G8	3523	1
			Metal Gold Hairline	E8333L1LED_GH_G8	3573	10
			Light Wood	E8333L1LED_LW_G8	4178	10
			Dark Wood	E8333L1LED_WD_G8	3573	10
	E8333L2_WE_G8	16AX 250V 3 gang 1 Way Switch with LED Indicator	White	E8333L2_WE_G8	1685	1
			Wine Gold	E8333L2_WG_G8	2529	10
			Dark Grey	E8333L2_DG_G8	2529	1
			Metal Gold Hairline	E8333L2_GH_G8	2566	10
	E8333L2_WD_G8		Dark Wood	E8333L2_WD_G8	2566	10
			White	E8333L2LED_WE_G8	2529	10
			Wine Gold	E8333L2LED_WG_G8	3793	10
			Dark Grey	E8333L2LED_DG_G8	3793	1
	E8333L2LED_WE_G8	16AX 250V 3 gang 2 Way Switch with LED Indicator	Metal Gold Hairline	E8333L2LED_GH_G8	3847	10
			Light Wood	E8333L2LED_LW_G8	4294	10
			Dark Wood	E8333L2LED_WD_G8	3847	10
			White	E8334L1_WE_G8	2252	1
	E8333L2LED_WD_G8		Wine Gold	E8334L1_WG_G8	3380	10
			Dark Grey	E8334L1_DG_G8	3380	1
			Metal Gold Hairline	E8334L1_GH_G8	3428	10
			Light Wood	E8334L1_LW_G8	3541	10
	E8334L1_WE_G8	16AX 250V 4 Gang 1 Way Switch	Dark Wood	E8334L1_WD_G8	3428	10
			White	E8334L1LED_WE_G8	3380	10
			Wine Gold	E8334L1LED_WG_G8	5068	10
			Dark Grey	E8334L1LED_DG_G8	5068	1
	E8334L1_WD_G8		Metal Gold Hairline	E8334L1LED_GH_G8	5141	10
			Light Wood	E8334L1LED_LW_G8	6012	10
			Dark Wood	E8334L1LED_WD_G8	5141	10
			White	E8334L2_WE_G8	2591	1
	E8334L1LED_WE_G8	16AX 250V 4 Gang 1 Way Switch with LED Indicator	Wine Gold	E8334L2_WG_G8	3885	10
			Dark Grey	E8334L2_DG_G8	3959	1
			Metal Gold Hairline	E8334L2_GH_G8	3941	10
			Dark Wood	E8334L2_WD_G8	3941	10
	E8334L1LED_WD_G8		White	E8334L2LED_WE_G8	3885	10
			Wine Gold	E8334L2LED_WG_G8	5829	10
			Dark Grey	E8334L2LED_DG_G8	5829	1
			Metal Gold Hairline	E8334L2LED_GH_G8	5912	10
	E8334L2_WE_G8	16AX 250V 4 Gang 2 Way Switch	White	E8334L2_WE_G8	2591	1
			Wine Gold	E8334L2_WG_G8	3885	10
			Dark Grey	E8334L2_DG_G8	3959	1
			Metal Gold Hairline	E8334L2_GH_G8	3941	10
	E8334L2_WD_G8		Dark Wood	E8334L2_WD_G8	3941	10
			White	E8334L2LED_WE_G8	3885	10
			Wine Gold	E8334L2LED_WG_G8	5829	10
			Dark Grey	E8334L2LED_DG_G8	5829	1
	E8334L2LED_WE_G8	16AX 250V 4 Gang 2 Way Switch with LED Indicator	Metal Gold Hairline	E8334L2LED_GH_G8	5912	10

Please contact Customer Care Center for Stockable and Non stockable status of references.
*Bold references are MTO reference.

AvatarOn - It's also a Switch



E8331M_WE_G8



E8331PRL1_WD_G8



E8332PRL1_WE_G8



E8332PRL1_WD_G8



E8331D20N_WE_G8



E8331D20N_WD_G8



E8331D32N_WE_G8



E8332D20N_WD_G8



E8331D32N_WD_G8



E8331D45N_WD_G8

Product Description	Color	Product Ref. No.	Unit MRP ₹	Pack
16A Intermediate Switches				
16AX 250V 1 Gang Intermediate Switch	White	E8331M_WE_G8	2095	1
	Wine Gold	E8331M_WG_G8	3142	1
	Dark Grey	E8331M_DG_G8	3142	1
10A Momentary Switches				
10A 250V 1 Gang Momentary Switch	Dark Wood	E8331PRL1_WD_G8	1120	10
	White	E8332PRL1_WE_G8	940	10
10A 250V 2 Gang Momentary Switch	Wine Gold	E8332PRL1_WG_G8	1407	10
	Dark Grey	E8332PRL1_DG_G8	1407	1
	Metal Gold Hairline	E8332PRL1_GH_G8	1407	10
	Dark Wood	E8332PRL1_WD_G8	1407	10
Double Pole Switches				
20A 250V 1 Gang Double Pole Switch with LED Indicator	White	E8331D20N_WE_G8	1612	10
	Wine Gold	E8331D20N_WG_G8	2414	10
	Dark Grey	E8331D20N_DG_G8	2414	1
	Metal Gold Hairline	E8331D20N_GH_G8	2437	10
	Light Wood	E8331D20N_LW_G8	2371	10
	Dark Wood	E8331D20N_WD_G8	2437	10
20A 250V 2 Gang Double Pole Switch with LED Indicator	Dark Wood	E8332D20N_WD_G8	2926	10
	White	E8331D32N_WE_G8	2138	10
32A 250V 1 Gang Double Pole Switch with LED Indicator	Wine Gold	E8331D32N_WG_G8	3206	10
	Dark Grey	E8331D32N_DG_G8	3206	1
	Metal Gold Hairline	E8331D32N_GH_G8	3236	10
	Light Wood	E8331D32N_LW_G8	3236	10
	Dark Wood	E8331D32N_WD_G8	3236	10
	Wine Gold	E8331D45N_WG_G8	4008	10
45A 250V 1 Gang Double Pole Switch with LED Indicator	Dark Grey	E8331D45N_DG_G8	4081	1
	Metal Gold Hairline	E8331D45N_GH_G8	4120	10
	Dark Wood	E8331D45N_WD_G8	3862	10

Please contact Customer Care Center for Stockable and Non stockable status of references.
*Bold references are MTO reference.

AvatarOn - It's also a Switch

		Product Description	Color	Product Ref. No.	Unit MRP ₹	Pack
Bell Push Switch						
 E8331BPL1_WE_G8	 E8331BPL1_WD_G8	10A 250V Door Bell Push Switch	White	E8331BPL1_WE_G8	682	1
			Wine Gold	E8331BPL1_WG_G8	1026	10
			Dark Grey	E8331BPL1_DG_G8	1021	1
			Metal Gold Hairline	E8331BPL1_GH_G8	1036	10
			Light Wood	E8331BPL1_LW_G8	1045	10
			Dark Wood	E8331BPL1_WD_G8	1036	10
Sockets						
 E8315_6_NS_WE	 E8315_6_NS_WD	6A 2/3 Pin Switched Socket	White	E8315_6_NS_WE	1358	8
			Wine Gold	E8315_6_NS_WG	1759	8
			Dark Grey	E8315_6_NS_DG	1726	1
			Metal Gold Hairline	E8315_6_NS_GH	1743	8
			Light Wood	E8315_6_NS_LW	1809	8
			Dark Wood	E8315_6_NS_WD	1743	8
 E8331FR350_WE_G8	 E8331FR350_WD_G8	6/16A Switched Socket	White	E8315_16_WE	1704	8
			Wine Gold	E8315_16_WG	2167	8
			Dark Grey	E8315_16_DG	2167	1
			Metal Gold Hairline	E8315_16_GH	2229	8
			Light Wood	E8315_16_LW	2271	8
			Dark Wood	E8315_16_WD	2188	8
Fan Regulators						
 E8331_WE	 E8331_WD	5 Steps 360 Deg Fan Regulator	White	E8331FR350_WE_G8	3235	1
			Wine Gold	E8331FR350_WG_G8	4264	1
			Dark Grey	E8331FR350_DG_G8	4264	1
			Metal Gold Hairline	E8331FR350_GH_G8	4264	1
			Light Wood	E8331FR350_LW_G8	4551	1
			Dark Wood	E8331FR350_WD_G8	4264	1
Switch & Socket Covers (Additional)						
 E8331_WE	 E8331_WD	1 Gang Switch Cover	White	E8331_WE	185	1
			Wine Gold	E8331_WG	513	1
			Metal Gold Hairline	E8331_GH	513	1
			Dark Wood	E8331_WD	513	1
 E8331KH_WE	 E8332_WD	1 Gang Switch Cover with Keyholder	White	E8331KH_WE	418	1
			Dark Wood	E8332_WD		
 E8332_WE	 E8333_WE	2 Gang Switch Cover	White	E8332_WE	279	1
			Wine Gold	E8332_WG	700	1
			Metal Gold Hairline	E8332_GH	700	1
			Light Wood	E8332_LW	686	1
			Dark Wood	E8332_WD	700	1
 E8332_WE	 E8333_WE	3 Gang Switch Cover	White	E8333_WE	432	1
			Wine Gold	E8333_WG	1028	1
			Metal Gold Hairline	E8333_GH	1028	1
			Light Wood	E8333_LW	1009	1

Please contact Customer Care Center for Stockable and Non stockable status of references.
*Bold references are MTO reference.

AvatarOn - It's also a Switch



E8334_WE



E8334_WD



E8315C_6_NC_WE



E8315C_6_NC_WD



E8332USB_WE_G8



E8315C_16_WD



E8332ACQUSB_WE



E8332USB_WD_G8



E8331_26_WE

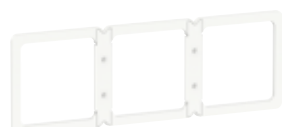

E8331_36_WE

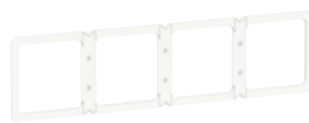

E8331_46_WE



E8330TX_WE

Product Description	Color	Product Ref. No.	Unit MRP ₹	Pack
4G Switch Cover	White	E8334_WE	676	1
	Wine Gold	E8334_WG	1262	1
	Dark Grey	E8334_DG	1205	1
	Metal Gold Hairline	E8334_GH	1402	1
	Light Wood	E8334_LW	1377	1
	Dark Wood	E8334_WD	1262	1
6A 2/3 Pin Switched Socket Cover	White	E8315C_6_NC_WE	482	12
	Wine Gold	E8315C_6_NC_WG	817	12
	Dark Grey	E8315C_6_NC_DG	817	1
	Metal Gold Hairline	E8315C_6_NC_GH	817	12
	Light Wood	E8315C_6_NC_LW	944	12
	Dark Wood	E8315C_6_NC_WD	817	12
	16A 2/3 Pin Switched Socket Cover	Wine Gold	E8315C_16_WG	854
Dark Grey		E8315C_16_DG	854	1
Metal Gold Hairline		E8315C_16_GH	948	12
Light Wood		E8315C_16_LW	941	12
Dark Wood		E8315C_16_WD	948	12
USB Chargers				
2 x 2.1A USB Charger with Mobile Holder (2.1A with 2 outputs used simultaneously)	White	E8332USB_WE_G8	8112	1
	Wine Gold	E8332USB_WG_G8	12168	1
	Dark Grey	E8332USB_DG_G8	12168	1
	Metal Gold Hairline	E8332USB_GH_G8	12168	1
	Light Wood	E8332USB_LW_G8	14422	1
	Dark Wood	E8332USB_WD_G8	12168	1
	Metal Gold Hairline	E8332ACQUSB_GH	7383	-
21W Type A+C, PD+QC3.0 USB Charger	Light Wood	E8332ACQUSB_LW	7913	-
	Dark Wood	E8332ACQUSB_WD	7383	-
	White	E8332ACQUSB_WE	5968	-
	Wine Gold	E8332ACQUSB_WG	7383	-
Bracket/Frame (to ensure alignment of switches on 2/3/4 Gang metal box)				
2 Gang Bracket/Frame	White	E8331_26_WE	306	1
	Wine Gold	E8331_26_WG	401	1
	Dark Grey	E8331_26_DG	382	1
3 Gang Bracket/Frame	White	E8331_36_WE	337	1
	Wine Gold	E8331_36_WG	472	1
	Dark Grey	E8331_36_DG	450	1
4 Gang Bracket/ Frame	White	E8331_46_WE	360	1
	Wine Gold	E8331_46_WG	506	1
	Dark Grey	E8331_46_DG	483	1
Blank Plates				
1 Gang Blank Plate	White	E8330X_WE	411	1
	Wine Gold	E8330X_WG	618	1
	Dark Grey	E8330X_DG	618	1
	Metal Gold Hairline	E8330X_GH	647	1
	Dark Wood	E8330X_WD	647	1
2 Gang Blank Plate	White	E8330TX_WE	574	10
	Wine Gold	E8330TX_WG	892	10
	Dark Grey	E8330TX_DG	892	1
	Metal Gold Hairline	E8330TX_GH	892	10

Please contact Customer Care Center for Stockable and Non stockable status of references.

*Bold references are MTO reference.

AvatarOn - It's also a Switch



E8331BPDMW_WE_G8



E8331KPB_WE



E8332C_WE_G8



E8332C_WD_G8



E83T727V_WE



E83T727V_WD



E8331RJS4_WE



E8331RJS4_WD

Product Description	Color	Product Ref. No.	Unit MRP ₹	Pack
Hotel Series				
DND, PCU, PW Indicator with Bell Switch (Do Not Disturb, Please Clean Up, Please Wait)	White	E8331BPDMW_WE_G8	5907	1
	Wine Gold	E8331BPDMW_WG_G8	8860	10
	Dark Grey	E8331BPDMW_DG_G8	8860	1
16AX 3 Gang Switch with PCU, DND, PW Sym (Do Not Disturb, Please Clean Up, Please Wait)	White	E8333DMWS_WE_G8	5622	1
	Wine Gold	E8333DMWS_WG_G8	8203	10
	Dark Grey	E8333DMWS_DG_G8	8593	1
	Dark Wood	E8333DMWS_WD_G8	8753	10
250V 16A Electronic Keycard Switch	White	E8331EKT_WE	10516	1
	Wine Gold	E8331EKT_WG	15775	1
	Dark Grey	E8331EKT_DG	15774	1
Panic Button with Key Reset	Dark Wood	E8331EKT_WD	16525	1
	White	E8331KPB_WE	1869	1
	Wine Gold	E8331KPB_WG	2746	1
10A 2 Gang Mechanical Curtain Switch	Dark Grey	E8331KPB_DG	2360	1
	White	E8332C_WE_G8	1224	1
	Wine Gold	E8332C_WG_G8	1836	10
	Dark Grey	E8332C_DG_G8	1836	1
	Metal Gold Hairline	E8332C_GH_G8	1836	10
115/240V 20VA Universal Version Shaver	Light Wood	E8332C_LW_G8	2041	10
	Dark Wood	E8332C_WD_G8	1836	10
	White	E83T727V_WE	5836	1
	Wine Gold	E83T727V_WG	9453	1
	Dark Grey	E83T727V_DG	9905	1
Connection Units	Metal Gold Hairline	E83T727V_GH	9905	1
	Dark Wood	E83T727V_WD	10376	1
	13A 250V 1 Gang Fused Connection with DP Switch and Neon	Wine Gold	E8331DFSGN_WG	5037
25A 250V 1 Gang Connection Unit	Metal Gold Hairline	E8331TB_GH	2301	10
Telecom, Network, Connectivity & Media Series				
1 Gang Telephone Socket, Shuttered Wallplate	White	E8331RJS4_WE	909	1
	Wine Gold	E8331RJS4_WG	1516	1
	Dark Grey	E8331RJS4_DG	1516	1
	Metal Gold Hairline	E8331RJS4_GH	1516	1
	Light Wood	E8331RJS4_GH	1516	1
	Dark Wood	E8331RJS4_WD	1516	1

Please contact Customer Care Center for Stockable and Non stockable status of references.
*Bold references are MTO reference.

AvatarOn - It's also a Switch



E8332RJS4_WE



E8331RJS5_WE



E8332RJS5_WE



E8331RJS6_WE



E8332RJS6_WE



E8331TV_WE



E8331TVSF_WE



E8332TDRJS5_WE



E8332TVRJS5_WE



E8332HDUSB_WE



E8332HDHD_WE



E8331RJS_WE



E8332RJS_WE

Product Description	Color	Product Ref. No.	Unit MRP ₹	Pack
2G Tel Socket, Shuttered Wallplate	White	E8332RJS4_WE	2231	1
	Wine Gold	E8332RJS4_WG	3350	1
1 Gang RJ45 Data Cat5E, Shuttered	White	E8331RJS5_WE	1421	1
	Wine Gold	E8331RJS5_WG	2479	1
	Dark Grey	E8331RJS5_DG	2366	1
	Metal Gold Hairline	E8331RJS5_GH	2366	1
	Dark Wood	E8331RJS5_WD	2479	1
2 Gang RJ45 Data Cat5E, Shuttered	White	E8332RJS5_WE	2598	1
	Wine Gold	E8332RJS5_WG	4333	1
	Dark Grey	E8332RJS5_DG	4136	1
1 Gang RJ45 Data Cat6, Shuttered	Metal Gold Hairline	E8332RJS5_GH	4136	10
	White	E8331RJS6_WE	1698	1
	Wine Gold	E8331RJS6_WG	2546	1
2 Gang RJ45 Data Cat6, Shuttered	Dark Grey	E8331RJS6_DG	2546	1
	White	E8332RJS6_WE	3182	1
	Wine Gold	E8332RJS6_WG	4774	1
1 Gang TV Socket, 75Ω, Through-Connect	Dark Grey	E8332RJS6_DG	4774	1
	White	E8331TV_WE	717	1
	Wine Gold	E8331TV_WG	1194	1
	Dark Grey	E8331TV_DG	1194	1
	Metal Gold Hairline	E8331TV_GH	1194	10
1 Gang TV Socket, Slave 5-1000	Dark Wood	E8331TV_WD	1194	1
	White	E8331TVSF_WE	792	10
	Wine Gold	E8331TVSF_WG	1327	0
1 Gang Tel + RJ45 Data Cat5E, Shuttered	Dark Grey	E8331TVSF_DG	1265	1
	White	E8332TDRJS5_WE	2231	1
	Wine Gold	E8332TDRJS5_WG	3720	1
	Dark Grey	E8332TDRJS5_DG	3551	1
	Metal Gold Hairline	E8332TDRJS5_GH	3551	1
1 Gang TV+ RJ45 Data Cat5E, Shuttered	Dark Wood	E8332TDRJS5_WD	3720	1
	White	E8332TVRJS5_WE	2767	1
	Wine Gold	E8332TVRJS5_WG	4617	1
	Dark Grey	E8332TVRJS5_DG	4406	1
	Metal Gold Hairline	E8332TVRJS5_GH	4406	1
1 Gang TV+ RJ45 Data Cat6, Shuttered	Dark Wood	E8332TVRJS5_WD	5130	1
	White	E8332TVRJS6_WE	2767	1
	Wine Gold	E8332TVRJS6_WG	4617	1
HDMI + USB Socket	Dark Grey	E8332TVRJS6_DG	4406	1
	White	E8332HDUSB_WE	5897	1
	Wine Gold	E8332HDUSB_WG	9827	8
2 Gang HDMI+HDMI, Keystone on Wallplate	Dark Grey	E8332HDUSB_DG	9379	1
	White	E8332HDHD_WE	3234	1
Volume Control, 5W, 8Ohm	Wine Gold	E8331VC_WG	3897	10
	Dark Grey	E8331VC_DG	3897	1
1 Gang S Keystone Wallplate (w/o Mod)	White	E8331RJS_WE	697	10
	Wine Gold	E8331RJS_WG	1046	10
	Dark Grey	E8331RJS_DG	1046	1
2 Gang S Keystone Wallplate (w/o Mod)	White	E8332RJS_WE	1310	10
	Wine Gold	E8332RJS_WG	1965	10
	Dark Grey	E8332RJS_DG	1965	1

Please contact Customer Care Center for Stockable and Non stockable status of references.
*Bold references are MTO reference.

Kavacha - Weather Protected Series



CSW110-GY-EX



A3031WBP_WE

- Pleasing looks with **IP56 protection**
- Large press switch
- Co-moulded sealing with no risk of gasket damage
- Chemical resistant & UV stabilised

Description	Reference	Unit MRP ₹	Pack
Kavacha IP56 Surface Mount Switches			
Switches with Looping Terminal			
10A 1 Gang 2 Way Switch	CSW110-GY-EX	4092	1
10A 1 Gang 2 Way Bell Press Return Switch	CSW110BPR-GY-EX	4492	1
Kavacha Heavy Duty Isolator Switches			
35A Triple Pole	WHT35-GY-EX	8726	1
63A Triple Pole	WHT63-GY-EX	11238	1
Kavacha IP56 Surface Mount Combined Switched Socket Outlets			
Combination Switch Socket Outlets			
16A Single Pole Switched Socket Outlet	CSC316RP_GY	4534	1
Kavacha IP56 Surface Mount Socket Outlets			
16A Socket Outlet	CSO316RP-GY-EX	3203	1
Kavacha Full-Time Weatherproof Cover			
Full-Time Weatherproof Single Gang Socket Cover (Transparent) IP55	E223R_TR	1160	1
Weatherproof Bell Press Grey	A3031WBP_GY	1771	1
Weatherproof Bell Press White	A3031WBP_WE	1548	1

Please contact Customer Care Center for Stockable and Non stockable status of references.
*Bold references are MTO reference.

Metal Boxes



- **Weld free design** to minimize corrosion and rusting without compromising on strength
- Mounting clip and earth pin designed for **easier installation** and to **avoid loss during transportation**
- Removable side plates and optimized knock outs and for **easier wiring**
- Completely tested & validated as per **IS 14772**

Description	Reference	Unit MRP ₹	Pack
Metal Boxes for Indian Format Ranges (Livia, Opale Clipsal X, Unica Pure & ZENcelo India)			
0.8 mm thickness			
Metal Box 1 & 2 modules	ME0102	111	20
Metal Box 3 modules	ME0103	145	20
Metal Box 4 modules	ME0104	167	20
1 mm thickness			
Metal Box 1 & 2 modules	MR1102	124	20
Metal Box 3 modules	MR1103	164	20
Metal Box 4 modules	MR1104	189	20
Metal Box 6 modules	MR1106	257	10
Metal Box 8 modules - Horizontal	MR1108	333	10
Metal Box 8 modules - Square	MR1109	333	10
Metal Box 12 module	MR1112	428	5
Metal Box 18 modules	MR1118	508	5

Description	Reference	Unit MRP ₹	Pack
Metal Boxes for BS Format Ranges (AvatarON) - New & Improved Design			
Use Bracket/Frame to ensure alignment of switches on 2/3/4 Gang Metal Box (refer to AvatarOn section for references)			
1 mm thickness			
2 GANG GI Metal Boxes	MM1102	312	20
3 GANG GI Metal Boxes	MM1103	442	20
4 GANG GI Metal Boxes	MM1104	572	20

- Special Metal Box with Gang Partition to accommodate BS format ranges
- Single Metal Box can accommodate up to 4 units
- Number of Gangs for Metal Box = Number of units that it can accommodate (Eg. 3 GANG Metal Box can accommodate up to 3 BS format Units)

Please contact Customer Care Center for Stockable and Non stockable status of references.
*Bold references are MTO reference.

Make your home **Smart** and **Sustainable** with **Wiser**



SE Ref.	Description of reference	Unit MRP [₹]
CS16A1MSW_WE*	16A 1M Connected Switch, White	7000
CD4SFR2M_WE*	4 Step Connected Fan Regulator, White	7500
CS16A1MSW_GY*	16A 1M Connected Switch, Grey	9000
CD4SFR2M_GY*	4 Step Connected Fan Regulator, Grey	9500
ENMOD1P*	Energy Monitoring Device, Single Phase	On Request
CCIRC1M*	IR Controller - WiFi	On Request
GR2CHRLYPG*	2 Channel Relay Puck - WiFi	On Request
IH11000200*	2 Channel Curtain Controller	On Request
IH12000020*	2 Channel Dimmer Controller	On Request
B1GTEWY*	Multi Protocol Gateway	On Request
IH100WFVDP*	Smart Doorbell	On Request
IH101ZW2IR*	ZW_IR Controller	On Request
IH101ZWIFI*	Automation Gateway	On Request
IH1200010F*	Fan Speed Controller	On Request
IH14000100*	4 Channel Automation Relay	On Request

Please contact Customer Care Center for Stockable and Non stockable status of references.

*Bold references are MTO reference.

Surface and Flush Mount Occupancy Sensors



PIR, Ultrasonic Sensors & High Frequency sensor suitable for both Surface & Flush Mount

Description	Reference	Unit MRP [₹]
Surface Mount Single-Load 360 degrees PIR	CSS54E_WE	3980
Flush/Surface Mount Single-Load 360 degrees PIR	SAE-UE-MS-CSAWE	4800
ARGUS Presence Dual-Tech PIR & Ultrasonic Sensor - 1ch	CCT551011	15789
ARGUS Presence Dual-Tech PIR & Ultrasonic Sensor - 2ch	CCT551012	16963
ARGUS IR Remote Controller Dual-Tech	CCT556011	21068
ARGUS Presence High Frequency High Bay Sensor - 2ch	CCT551023	18564
ARGUS IR Remote Controller HF	CCT556023	19313
ARGUS Presence Wide Sense - 2ch	CCT551003	15718
INFRASCAN OUTDOOR 3WIRE 10A	750WPR-GY	22594
INFRASCAN INDOOR 3WIRE 10A	751R-WE	13109
INFRASCAN 360 DEGREE 3WIRE	753R-WE	12020



PIR Flush Mount Sensors

Description	Reference	Unit MRP [₹]
ARGUS Standard min 360° False ceiling indoor movement detector	CCT570005	5617
ARGUS Standard 360° False ceiling indoor movement detector - 2ch	CCT570003	8247
Flush Mount Dual load 360 degrees standalone sensor	SAE-UE-MS-CDBWE	9577



Dimmable Sensors with Light Regulation

0-10V Analogue & Dali Dimmable Sensor

Description	Reference	Unit MRP [₹]
ARGUS Presence Master with IR, DALI	MTN5510-1519	16963

Please contact Customer Care Center for Stockable and Non stockable status of references.
*Bold references are MTO reference.

Wall Mount Sensors



BS Standard & Outdoor IP55 Sensor

Description	Reference	Unit MRP [₹]
Neo C-Metro 200 degrees wall mount sensor, grey colour	E3751MS3C_GS	7545
Zencelo 110 degrees wall mount sensor, white colour	E84751MS3B_WE	6361
Zencelo 90 degrees wall mount sensor, white colour	E84751MS3A_WE	6058
Argus 110 Electronic outdoor movement detector, angle of detection 110 degrees, max. range 12 mtrs, IP55 protection	MTN565119	8270
Argus 220 Electronic movement detector for outdoor ceiling mounting angle of detection 220 degrees, max. range 12 mtrs, IP55 protection	MTN565219	12760

Hotel - ELV Dual Motion Sensor

Description	Reference	Unit MRP [₹]
ELV DUAL TECH MOTION SENSOR	SAE_UE_MS_CULV_WE	10491

Please contact Customer Care Center for Stockable and Non stockable status of references.
*Bold references are MTO reference.

Life Is 

Schneider
 Electric

Schneider Electric India Pvt. Ltd.

Corporate Office: 9th Floor, DLF Building No. 10, Tower C, DLF Cyber City, Phase II, Gurugram - 122002, Haryana
Tel: 0124 3940400, www.se.com/in

Ahmedabad
Schneider Electric India (P) Ltd.
1506-1507, 15th Floor Shapth-5
Opp.Karnavati Club, SG Highway,
Ahmedabad, Gujarat - 380015
Tel.: 079-66826701

Coimbatore
Schneider Electric India Pvt. Ltd.
Mikro Grafeio Services Pvt Ltd.,
Elysium Tower, #21, A.T.T
Colony, Near Honda Office,
Coimbatore, Tamil Nadu - 641018

Lucknow
Schneider Electric India (P) Ltd.
Summit, Plot No. TCG 3/3
6th Floor, 604A/B/C, Vibhuti Khand
Gomti Nagar, Lucknow
Uttar Pradesh - 226010
Tel.: 0522-3500334

Nashik
Schneider Electric India (P) Ltd.
401, 4th Floor, Rishi Raj Towers
Jehan Circle, Gangapur Road
Nashik - 422013
Tel.: 0253-2344333

Bengaluru
Schneider Electric India (P) Ltd.
No. 3/1, JP Techno Park
Mezzanine Floor, Millers Tank Bund
Road, Vasanth Nagar
Bengaluru - 560052
Tel.: 080-71481351

Hyderabad
Schneider Electric Pvt. Ltd.
4B-4th Floor, Gumidelli Towers,
Prakash Nagar, Begumpet,
Hyderabad - 500016

Ludhiana
Schneider Electric India (P) Ltd.
SCO 23, 2nd Floor,
Chandigarh Road, Sector 32
Ludhiana, Punjab -141010
Tel.: 0161- 5203011

New Delhi
Schneider Electric India (P) Ltd.
C-56, Mayapuri Industrial Area, Phase-2
New Delhi - 110064
Tel.: 011-61317400

Bhubaneswar
Schneider Electric India (P) Ltd.
Workloop Co-Working in the property
Office No. 316, Esplanade One Mall
Rasulgarh, Bhubaneswar - 751010

Indore
Schneider Electric India (P) Ltd.
219, Dhan Trident Building
Vijay Nagar, A.B.Road
Indore - 452001

Mohali
Schneider Electric India (P) Ltd.
2nd Floor, Tower-A
Bestech Business Tower
Mega Information & Technology Park
Industrial Plot No.1, Phase IX
(Expansion), Mohali - 160059
Tel.: 0172-7198200

Pune
Schneider Electric India (P) Ltd.
Amar Caliber, CTS No 911, BMCC Road,
OFF F.C. Road, Deccan Gymkhana,
Shivaji Nagar, Pune - 411007
Tel.: 020-67492500

Chennai
Schneider Electric India (P) Ltd.
No: 29, 2nd Floor,
Bannari Amman Towers, B-Block
Dr. Radhakrishnan Road, Mylapore
Chennai - 600 004
Tel.:044-71912000

Jaipur
Schneider Electric India (P) Ltd.
Jaipur Business Centre 309
3rd Floor, Sangam Tower 190
Church Road, Jaipur - 302001
Tel.: 0141-2374810

Mumbai
Schneider Electric India Pvt. Ltd.
L&T Business Park, Tower B,
7th Floor, TC-II, Gate No.5,
Saki Vihar Road, Powai,
Mumbai - 400072

Vadodara
Schneider Electric India (P) Ltd.
Notus IT Park, 10th Floor, Block-D
Sarabhai Campus, Vadiwadi
Vadodara, Gujarat - 390017

Cochin
Schneider Electric India (P) Ltd.
Alapatt Properties Private Limited
(Trade Name: Centre A)
Main Door Number: 66/4971
(Old Door Number: 40/6584-H)
7th Floor Alapatt Heritage Building
MG Road Kochi - 682035

Kolkata
Schneider Electric (I) Pvt. Ltd.
BN3, Salt Lake, Sector V,
Kolkata - 700091

Nagpur
Schneider Electric India (P) Ltd.
6, Vasant Vihar Complex
W.H.C Road, Shankar Nagar
Nagpur - 440010
Tel.: 0712-2558581

Vishakhapatnam
Schneider Electric India (P) Ltd.
D.N.10-1-43, 1st Floor
Ratnam's Business Centre,
Siripuram Fort, C.B.M.Compound
Visakhapatnam - 530016
Tel.: 0891-6675500

Customer Care Centre

Monday-Saturday, 9 a.m. to 8 p.m.

Toll-free numbers: 1800 419 4272, 1800 103 0011

Email: customercare.in@schneider-electric.com

For more information, visit our website at: www.se.com/in

- All Prices are in Indian Rupees.
- Prices are subject to change without prior notice.
- Product evolution is a continuous process and Schneider Electric reserves the right to modify/withdraw any product at any time without prior notice.
- Prices charged will be as prevailing on the date of dispatch.
- Invoice Amount = (MRP – less Applicable discount) + Applicable GST %
- Tax incidence on invoices is basis applicable GST rates.
- Invoice amount not to exceed MRP.
- Product pictures shown are for illustration purpose only, actual product may vary.

Distributor