

Life Is On

Schneider
Electric



 PriceList

Switching and Controlling Products

With effect from February 03rd, 2025



se.com/in

Easy TeSys

- > **Easy** TeSys Power Contactors (3 Pole) 08
- > **Easy** TeSys Power Contactors (4 Pole) 09
- > **Easy** TeSys Contactor Accessories 10
- > **Easy** TeSys Thermal Overload Relay 12
- > **Easy** TeSys Circuit Breaker for Motor Protection 13

TeSys Control

- > TeSys K Control Relays 18
- > TeSys K Power Contactors 18
- > TeSys K Accessories 19
- > TeSys Capacitor Duty Contactor 20
- > TeSys Deca Control Relays 21
- > TeSys Deca Power Contactors (3 Pole) 21
- > TeSys Deca Power Contactors (4 Pole) 22
- > TeSys Deca Advanced Contactor (3 Pole) 26
- > TeSys Deca Advanced Contactor (4 Pole) 26
- > TeSys Deca Accessories 28
- > TeSys Giga Power Contactors 36
- > TeSys Giga Accessories 37

TeSys Protect

- > TeSys Overload Relay 41
- > Electronic Over Current Relay 43

TeSys Power

- > TeSys Motor Circuit Breakers 46
- > Circuit Breakers for Motor Protection Accessories 47

TeSys Switches

- > TeSys Switches 50

TeSys Active

- > TeSys Island 52
- > TeSys U 54
- > TeSys T - iMCC Relays 56



Easy TeSys

Powering Simplicity in Control Solutions

Easy TeSys provides you **Essential** control and protection for your applications.



www.se.com/in

Life Is On

Schneider
Electric

Easy TeSys

The Easy choice for simplicity and flexibility

- 3 Pole and 4 Pole Power Contactor
- Control Relays
- Thermal Overload Relay
- Circuit Breaker for Motor Protection
- Accessories

A2L certified
upto 50A
for HVAC
applications

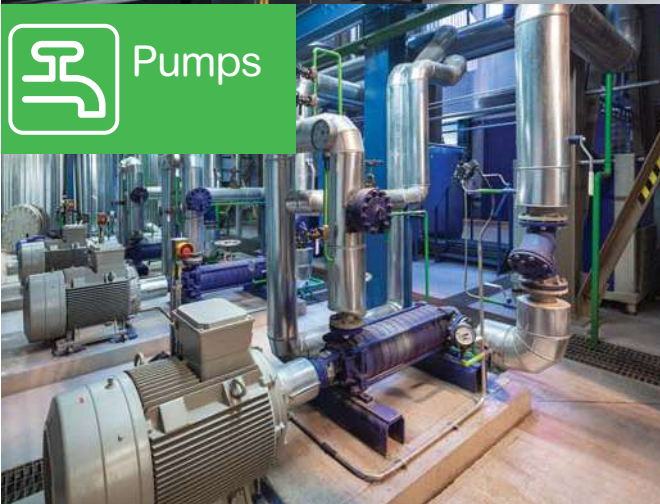

Easy TeSys

Designed for the essential

Two principles to build your starter solution

2-components solution

(Thermal-magnetic circuit breaker + Contactor)

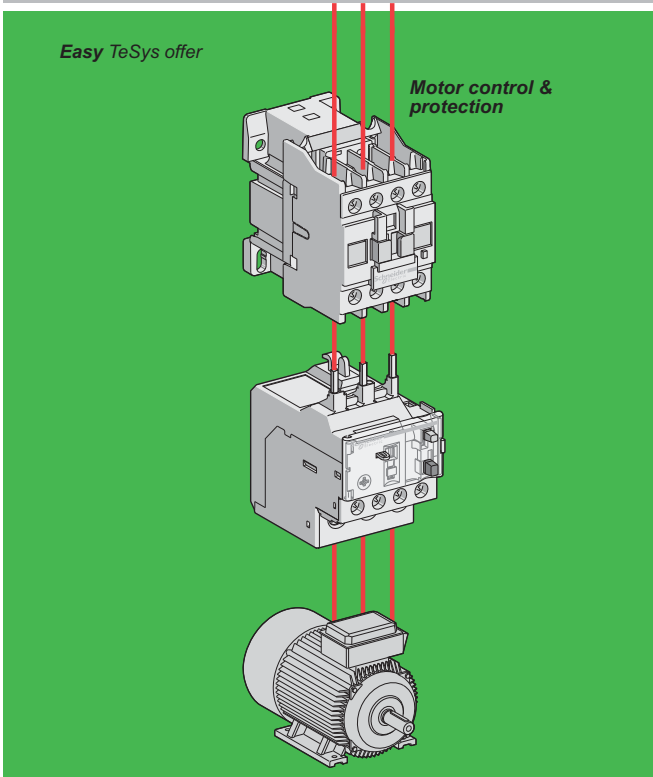
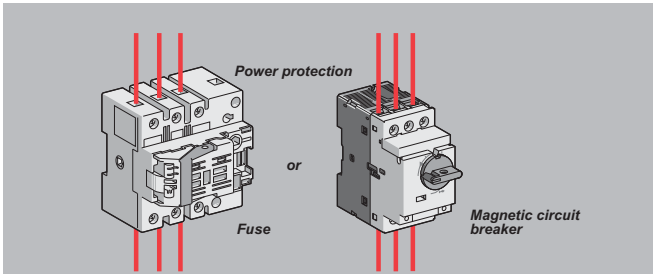

3-components solution

(Magnetic circuit breaker or fuse + Contactor + TOR)

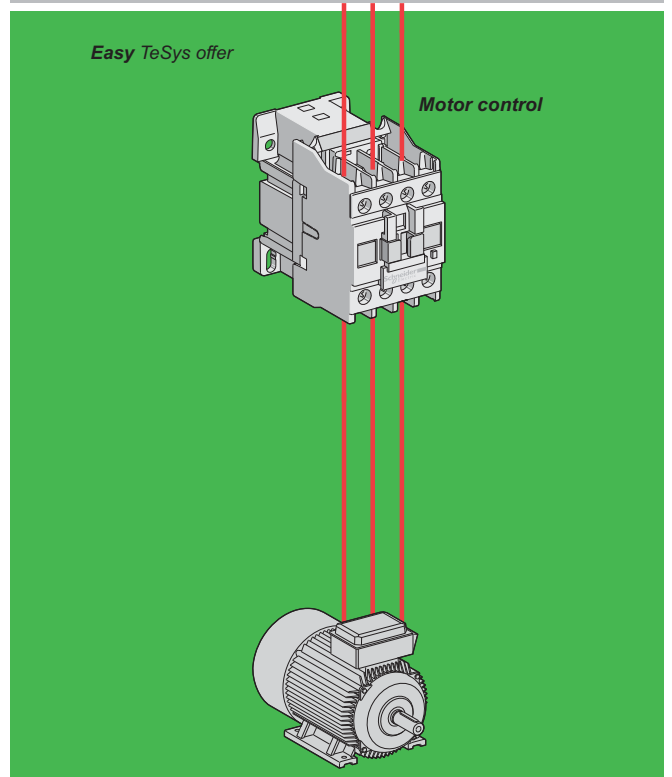
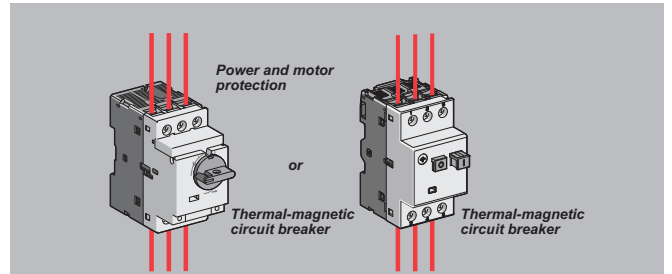

To build the essential solutions
in an easy and simple way

Control

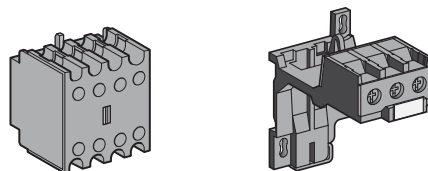

Terminal block

Reversor starter

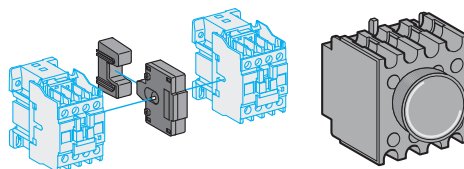

Star-Delta solution

Power Contactors LC1E (3 Pole AC Control)



- Conformance to IEC 60947-4-1, CE Marking
- Current Rating: 6A to 630A, AC-3 Rating
- RSC available with Fuse, MPCB and MCCB

Frame	[Ie] Rated Operational Current		Motor Power at 415V, 3Ph, 50Hz		Auxiliary Contacts		Reference	Unit MRP [₹]	
	AC-1	AC-3	HP	kW	NO	NC		M7 (220V)	N5 (415V)
FRAME-1	20 A	6 A	3	2.2	-	1	LC1E0601* <input checked="" type="checkbox"/>	1485	1750
	20 A	6 A	3	2.2	1	-	LC1E0610* <input checked="" type="checkbox"/>	1485	-
	25 A	9 A	5.5	4	-	1	LC1E0901* <input checked="" type="checkbox"/>	1520	1520
	25 A	9 A	5.5	4	1	-	LC1E0910* <input checked="" type="checkbox"/>	1520	1520
	25 A	12 A	7.5	5.5	-	1	LC1E1201* <input checked="" type="checkbox"/>	1735	1735
	25 A	12 A	7.5	5.5	1	-	LC1E1210* <input checked="" type="checkbox"/>	1735	1735
	32 A	18 A	12	9	-	1	LC1E1801* <input checked="" type="checkbox"/>	2005	2005
	32 A	18 A	12	9	1	-	LC1E1810* <input checked="" type="checkbox"/>	2005	2005
	36 A	25 A	15	11	-	1	LC1E2501* <input checked="" type="checkbox"/>	2730	3230
	36 A	25 A	15	11	1	-	LC1E2510* <input checked="" type="checkbox"/>	2730	2730
FRAME-2	50 A	32 A	20	15	-	1	LC1E3201* <input checked="" type="checkbox"/>	5720	6765
	50 A	32 A	20	15	1	-	LC1E3210* <input checked="" type="checkbox"/>	5720	5720
	50 A	38 A	25	18.5	-	1	LC1E3801* <input checked="" type="checkbox"/>	6670	7995
	50 A	38 A	25	18.5	1	-	LC1E3810* <input checked="" type="checkbox"/>	6670	6670
	50 A	40 A	29	22	-	1	LC1E40B01* <input checked="" type="checkbox"/>	7210	-
	50 A	40 A	29	22	1	-	LC1E40B10* <input checked="" type="checkbox"/>	7210	-
FRAME-3	60 A	40 A	29	22	1	1	LC1E40* <input checked="" type="checkbox"/>	8955	8955
	70 A	50 A	34	25/30	1	1	LC1E50* <input checked="" type="checkbox"/>	10895	10895
	80 A	65 A	50	37	1	1	LC1E65* <input checked="" type="checkbox"/>	14760	14760
FRAME-4	110 A	80 A	60	45	1	1	LC1E80* <input checked="" type="checkbox"/>	19195	19195
	120 A	95 A	60	45	1	1	LC1E95* <input checked="" type="checkbox"/>	23005	23005

Frame	[Ie] Rated Operational Current		Motor Power at 415V, 3Ph, 50Hz		Auxiliary Contacts		Reference	Unit MRP [₹]			
	AC-1	AC-3	HP	kW	NO	NC		M7 (220V)	N5 (415)	M5 (220V)	N7 (415)
FRAME-5	150 A	120 A	75	55	1	1	LC1E120*	-	27410	27410	-
	200 A	160 A	120	90	1	1	LC1E160*	-	36190	36190	-
FRAME-6	250 A	200 A	150	110	-	-	LC1E200*	-	49810	49810	-
	300 A	250 A	175	132	-	-	LC1E250*	-	77580	65640	-
FRAME-7	320 A	300 A	215	160	-	-	LC1E300*	-	80810	80810	-
	500 A	400 A	295	220	-	-	LC1E400*	100850	-	-	118050
FRAME-8	700 A	500 A	375	280	-	-	LC1E500*	142050	-	-	-
FRAME-9	1000 A	630 A	500	375	-	-	LC1E630*	199820	-	-	236070

For other coil voltage ratings contactors, please contact Customer Care.

* Reference to be completed by adding coil voltage code

Easy TeSys 3P Power Contactors 06 – 95A, 24V DC Coil



- Power Contactors – 6A to 95A, Control Voltage- 24V DC (launched and commercialized)
- Fully tested, approved, and certified by national, international, and third-party organizations. ISO 9001 ISO 14000
- Conformance to IEC 60947-4-1, CE Marking

Power Contactors LC1E (3 Pole DC Control)

Frame	[Ie] Rated Operational Current		Motor Power at 415V, 3Ph, 50Hz		Auxiliary Contacts		Reference	Unit MRP [₹] BD
	AC-1	AC-3	HP	kW	NO	NC		
FRAME-1	20 A	6 A	3	2.2	-	1	LC1E0601* ✓	2905
	20 A	6 A	3	2.2	1	-	LC1E0610* ✓	2905
	25 A	9 A	5.5	4	-	1	LC1E0901* ✓	2905
	25 A	9 A	5.5	4	1	-	LC1E0910* ✓	2905
	25 A	12 A	7.5	5.5	-	1	LC1E1201* ✓	3005
	25 A	12 A	7.5	5.5	1	-	LC1E1210* ✓	3005
	32 A	18 A	12	9	-	1	LC1E1801* ✓	3505
	32 A	18 A	12	9	1	-	LC1E1810* ✓	3505
	36 A	25 A	15	11	-	1	LC1E2501* ✓	4810
	36 A	25 A	15	11	1	-	LC1E2510* ✓	4810
FRAME-2	50 A	32 A	20	15	-	1	LC1E3201* ✓	10520
	50 A	32 A	20	15	1	-	LC1E3210* ✓	10520
	50 A	38 A	25	18.5	-	1	LC1E3801* ✓	12025
FRAME-3	50 A	38 A	25	18.5	1	-	LC1E3810* ✓	12025
	60 A	40 A	29	22	1	1	LC1E40** ✓	18105
	70 A	50 A	34	25/30	1	1	LC1E50**	18295
FRAME-4	80 A	65 A	50	37	1	1	LC1E65** ✓	19140
	110 A	80 A	60	45	1	1	LC1E80** ✓	24690
	120 A	95 A	60	45	1	1	LC1E95** ✓	26965

Power Contactors - Easy TeSys (4 Pole AC Control)



- Conformance to IEC 60947-4-1, CE Marking
- Current Rating: 20A to 125A, AC-1 rating
- Available in 4NO and 2NO+2NC Power Pole combination
- Wide Band Coil for all ratings in 220 & 415V AC

Frame	AC-1 Rating	Power Poles	Reference	Unit MRP [₹]			
				B7 (24V)	F7 (110V)	M5WB (220V)	N5WB (415V)
FRAME-1	20	4NO	LC1E06004*IN	1815	2160	1815	-
	25	4NO	LC1E09004*IN	1925	2285	1925	2285
	32	4NO	LC1E12004*IN	-	-	2005	-
	40	4NO	LC1E18004*IN	2500	2500	2500	2500
FRAME-2	50	4NO	LC1E25004*IN	3165	3165	3165	3165
	55	4NO	LC1E32004*IN	-	5345	5345	-
	60	4NO	LC1E38004*IN	6255	6255	6255	6255
FRAME-3	75	4NO	LC1E40004*IN	11790	11790	9745	11790
	85	4NO	LC1E65004*IN	13185	15950	13185	13185
FRAME-4	110	4NO	LC1E80004*IN	20200	20200	16700	-
	125	4NO	LC1E95004*	-	-	18830	-

For details on non standard references, technical parameters, accessories, compatibility, stockable and non stockable status please contact Customer Care

✓ NORMAL STOCK ITEMS

W.E.F. February 03rd, 2025

Frame	AC-1 Rating	Power Poles	Reference	Unit MRP [₹]			
				B7 (24V)	F7 (110V)	M5WB (220V)	N5WB (415V)
FRAME-1	20	2NO + 2NC	LC1E06008*IN	-	-	2170	-
	25	2NO + 2NC	LC1E09008*IN	2335	2335	2335	2335
	32	2NO + 2NC	LC1E12008*IN	2975	2975	2500	-
FRAME-2	40	2NO + 2NC	LC1E18008*IN	2515	2515	2515	2515
	50	2NO + 2NC	LC1E25008*IN	-	4500	4500	5345
	55	2NO + 2NC	LC1E32008*IN	8480	-	-	8480
FRAME-3	60	2NO + 2NC	LC1E38008*IN	-	8840	8840	8840
	75	2NO + 2NC	LC1E40008*IN	13100	-	13100	15840
	85	2NO + 2NC	LC1E65008*IN	-	16375	16375	16375
FRAME-4	110	2NO + 2NC	LC1E80008*IN	-	-	23250	23250

For other coil voltage ratings contactors, please contact Customer Care.

* Reference to be completed by adding coil voltage code

Control Relays - CAE,

Conformance to IEC60947-5-1, CE Marking

Auxiliary Contacts Reference			Unit MRP [₹]			
NO	NC		B5	F5	M5	N5
4	0	CAE40*	1775	1485	1485	1485
3	1	CAE31*	1775	1775	1485	1775
2	2	CAE22*	1775	1485	1485	1775

* Reference to be completed by adding coil voltage code and recommended to check availability with Customer Care team

Spare Coil for Contactors

Contactor	Reference
4 Pole Contactors	
LC1E0600*.... LC1E1800*	LAEX1T**
LC1E2500*.... LC1E3800*	LAEX2T**
LC1E4000*....LC1E9500*	LAEX4T**
Control Contactors	
CAE*	LAEX12**

* Reference to be completed by adding coil voltage code and recommended to check availability with Customer Care team

Accessories - For Easy TeSys Contactors

Description	For Use with	Mounting	Contacts	Reference	Unit MRP [₹]
Auxiliary contact block	LC1E06..E630 & LC1E0600..E9500	FRONT	1NO+1NC	LAEN11 <input checked="" type="checkbox"/>	465
		FRONT	2NO	LAEN20 <input checked="" type="checkbox"/>	465
		FRONT	2NC	LAEN02 <input checked="" type="checkbox"/>	550
		FRONT	2NO+2NC	LAEN22 <input checked="" type="checkbox"/>	845
		FRONT	4NO	LAEN40 <input checked="" type="checkbox"/>	845
Star delta timer	LC1E25..E630			LAETSD <input checked="" type="checkbox"/>	3830

Description	For Use with	Coil Voltage	Reference	Unit MRP [₹]
Surge suppressor*	LC1E06...E95	24..48V AC	LAERCE	2530
	LC1E06...E95	110..240V AC	LAERCU	1075

*For higher rating contactors, contact Customer Care

Description	For Use with	Reference	Unit MRP [₹]
Mechanical Interlock	LC1E06..E65 & LC1E0600*..E3800*	LAEM1	960
	LC1E80/E95 & LC1E4000*...LC1E9500*	LAEM4	3120
	LC1E120..E160	LAEM5	5820
	LC1E200/E250	LAEM6	5935

*Reference to be completed by adding coil voltage

For details on non standard references, technical parameters, accessories, compatibility, stockable and non stockable status please contact Customer Care

NORMAL STOCK ITEMS

W.E.F. February 03rd, 2025

Easy TeSys

3 Pole Accessories Compatibility

Contactor	Built in contacts	LAEN**	LAERC*	LAEM
LC1E06	1NO or 1NC	1	-	-
LC1E09				
LC1E12				
LC1E18				
LC1E25				
LC1E32				
LC1E38				
LC1E40B	1NO + 1NC	1	-	1
LC1E40				
LC1E50				
LC1E65				
LC1E80				
LC1E95	-	2	-	-
LC1E120				
LC1E160				
LC1E200				
LC1E250				
LC1E300				
LC1E400				
LC1E500				
LC1E630				

4 Pole Accessories Compatibility

Contactor	LAEN**	LAEM	LAERC*
LC1E06	1	1	1
LC1E09			
LC1E12			
LC1E18			
LC1E25			
LC1E32			
LC1E38			
LC1E40			
LC1E50			
LC1E65			
LC1E80	-	-	-
LC1E95			

Control Relay Accessories Compatibility

Control Relay	LAEN*	LAERC
CAE	1 of LAEN11 or LAEN20 or LAEN02 or LAEN22	1

Easy TeSys

The performance you need

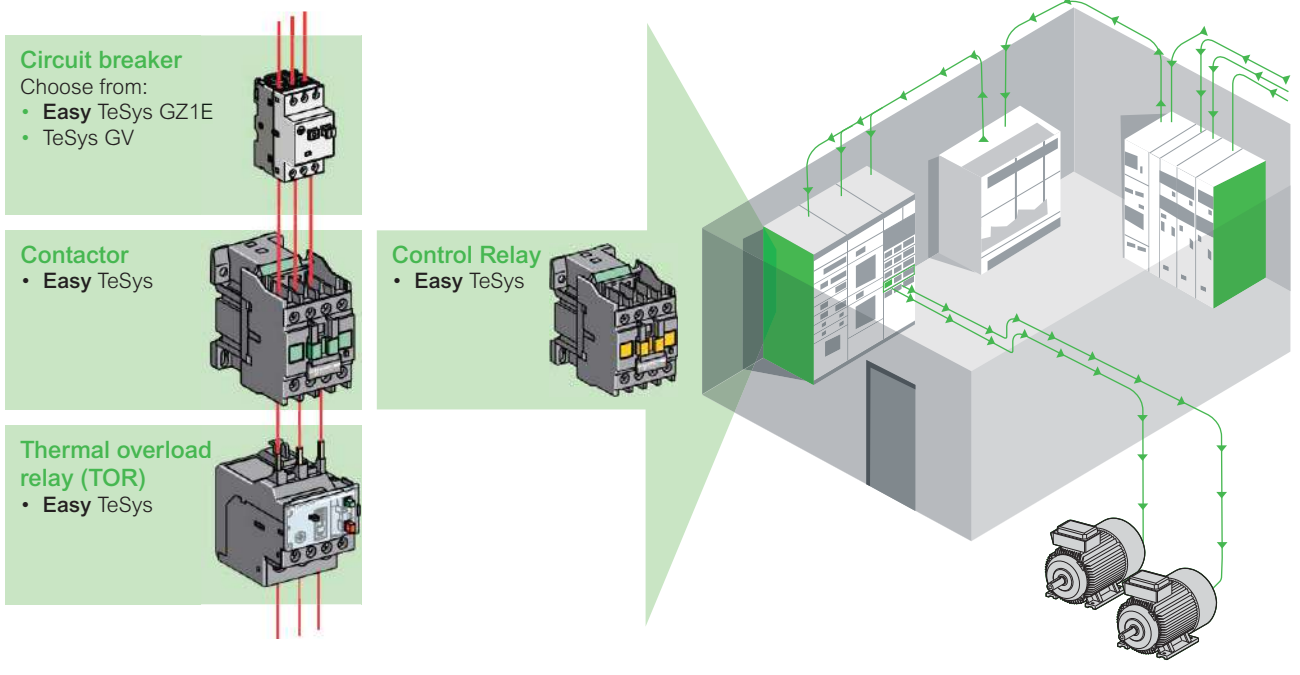

For details on non standard references, technical parameters, accessories, compatibility, stockable and non stockable status please contact Customer Care

NORMAL STOCK ITEMS

W.E.F. February 03rd, 2025

Thermal Overload Relay - Easy TeSys



- Conformance to IEC 60947-4-1, CE Marking
- Range : 0.1A to 630A
- Tripping Class : 10A
- Direct & Independent mounting

Thermal Protection Adjustment Range	For Use with Contactor	Reference	Unit MRP [₹]
LRE			
0.25...0.4	E06...E38	LRE03	2435
0.4...0.63	E06...E38	LRE04	2435
0.63...1	E06...E38	LRE05 <input checked="" type="checkbox"/>	2435
1...1.6	E06...E38	LRE06 <input checked="" type="checkbox"/>	2435
1.6...2.5	E06...E38	LRE07 <input checked="" type="checkbox"/>	2435
2.5...4	E06...E38	LRE08 <input checked="" type="checkbox"/>	2435
4...6	E06...E38	LRE10 <input checked="" type="checkbox"/>	2435
5.5...8	E09...E38	LRE12 <input checked="" type="checkbox"/>	2435
7...10	E09...E38	LRE14 <input checked="" type="checkbox"/>	2435
9...13	E12...E38	LRE16 <input checked="" type="checkbox"/>	2435
12...18	E18...E38	LRE21 <input checked="" type="checkbox"/>	2695
16...24	E25...E38	LRE22 <input checked="" type="checkbox"/>	3115
23...32	E25...E38	LRE32 <input checked="" type="checkbox"/>	4165
30...38	E38	LRE35 <input checked="" type="checkbox"/>	4690
17...25	E40...E95	LRE322	5295
23...32	E40...E95	LRE353	5295
30...40	E40...E95	LRE355	5295
37...50	E50...E95	LRE357 <input checked="" type="checkbox"/>	5295
48...65	E65...E95	LRE359	6945

Thermal Protection Adjustment Range	For Use with Contactor	Reference	Unit MRP [₹]
LRE			
55...70	E80...E95	LRE361	8225
63...80	E80...E95	LRE363	8590
80...104	E95	LRE365	8590
51...81	E120...E300	LRE480	16085
62...99	E120...E300	LRE481	16085
84...135	E120...E300	LRE482	16085
124...198	E160...E300	LRE483	16085
146...234	E200...E300	LRE484	16085
174...279	E250...E300	LRE485	16085
208...333	E300	LRE486	17530
258...414	E300...E400	LRE487	21325

Accessories for Relay

Accessory	For Relay	Reference	Unit MRP [₹]
Separate Mounting Block	LRE01...LRE35	LAEB1	865
	LRE322...LRE365	LAEB3	1995

For details on non standard references, technical parameters, accessories, compatibility, stockable and non stockable status please contact Customer Care

NORMAL STOCK ITEMS

W.E.F. February 03rd, 2025

Circuit Breaker for Motor Protection - GZ1E - Pushbutton control



- Conformance to IEC60947-1,-2,-4, CE Marking
- Range : 0.1A to 32A
- Breaking Capacity upto 100KA

Motor Protection Circuit Breaker - Easy TeSys

Breaking Capacity at 50 Hz		Thermal Protection Adjustment Range (A)	Reference	Unit MRP [₹]
690 V	500 V			
GZ1-E Thermal Magnetic - With Pushbutton Control				
100 kA	100 kA	0.1 - 0.16	GZ1E01	4505
		0.16 - 0.25	GZ1E02	4505
		0.25 - 0.40	GZ1E03	4505
		0.40 - 0.63	GZ1E04	5245
		0.63 - 1.0	GZ1E05	5245
2 kA	100 kA	1.0 - 1.6	GZ1E06	5140
		1.6 - 2.5	GZ1E07	5140
2 kA	30 kA	2.5 - 4	GZ1E08	5340
	8 kA	4 - 6.3	GZ1E10	5340
2 kA	5 kA	6 - 10	GZ1E14	5690
		9 - 14	GZ1E16	6415
2 kA	3 kA	13 - 18	GZ1E20	6975
		17 - 23	GZ1E21	7355
		20 - 25	GZ1E22	7725
		24 - 32	GZ1E32	13785

Breaking Capacity at 50 Hz		Magnetic Protection (A)	Reference	Unit MRP [₹]
690 V	500 V			
GZ1-LE Magnetic- With Pushbutton Control				
100 kA	100 kA	1	GZ1LE05	3290
		1.6	GZ1LE06	3290
2 kA	100 kA	2.5	GZ1LE07	3290
		4	GZ1LE08	3290
2 kA	38 kA	6.3	GZ1LE10	3290
	8 kA	10	GZ1LE14	3290
2 kA	5 kA	14	GZ1LE16	3555
		18	GZ1LE20	3555
2 kA	3 kA	25	GZ1LE22	3555
		32	GZ1LE32	4215

Accessories - Easy TeSys Circuit Breaker for Motor Protection

Description	Mounting	Contacts	Reference	Unit MRP [₹]
Auxillary Contact Block	LH side Mounted	1NO+1NC	GZ1AN11	845
		2NO	GZ1AN20	1095

For details on non standard references, technical parameters, accessories, compatibility, stockable and non stockable status please contact Customer Care

NORMAL STOCK ITEMS

W.E.F. February 03rd, 2025



years of **TeSys...**

> Control > Protect > Power > Active

Innovative and connected solutions for motor starters

TeSys is an innovative motor control and management solution from the global market leader. TeSys offers connected, efficient products and solutions for switching and protection of motors and electrical loads in compliance with all major global electrical standards

TeSys Function Names

TeSys components are grouped by function name, for easier identification. These functions are related to motor, power, control and protection.

> TeSys Power:

Components for powering motors



> TeSys Control:

Components for controlling motors



> TeSys Protect:

Components for protecting motors

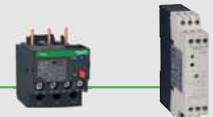

> TeSys Active:

Connected components for motor circuits



Start smart. Run smart. With TeSys motor controls.



Stay smart with the world's best-selling motor control solutions from the inventor of the world's first contactor - Schneider Electric™.

For almost a century, TeSys motor controls have driven the industry with innovations in motor protection, monitoring, and control.

It started with the introduction of the industry's first BAR contactor in 1924, and today, the legacy of innovation is built into every TeSys motor control device.

Best-in-class safety and reliability, plug-and-play architecture, and flexible functionality mean TeSys motor control solutions can meet your requirements across a wide range of applications, from the most common to the most advanced.

A Century of Innovation and Leadership

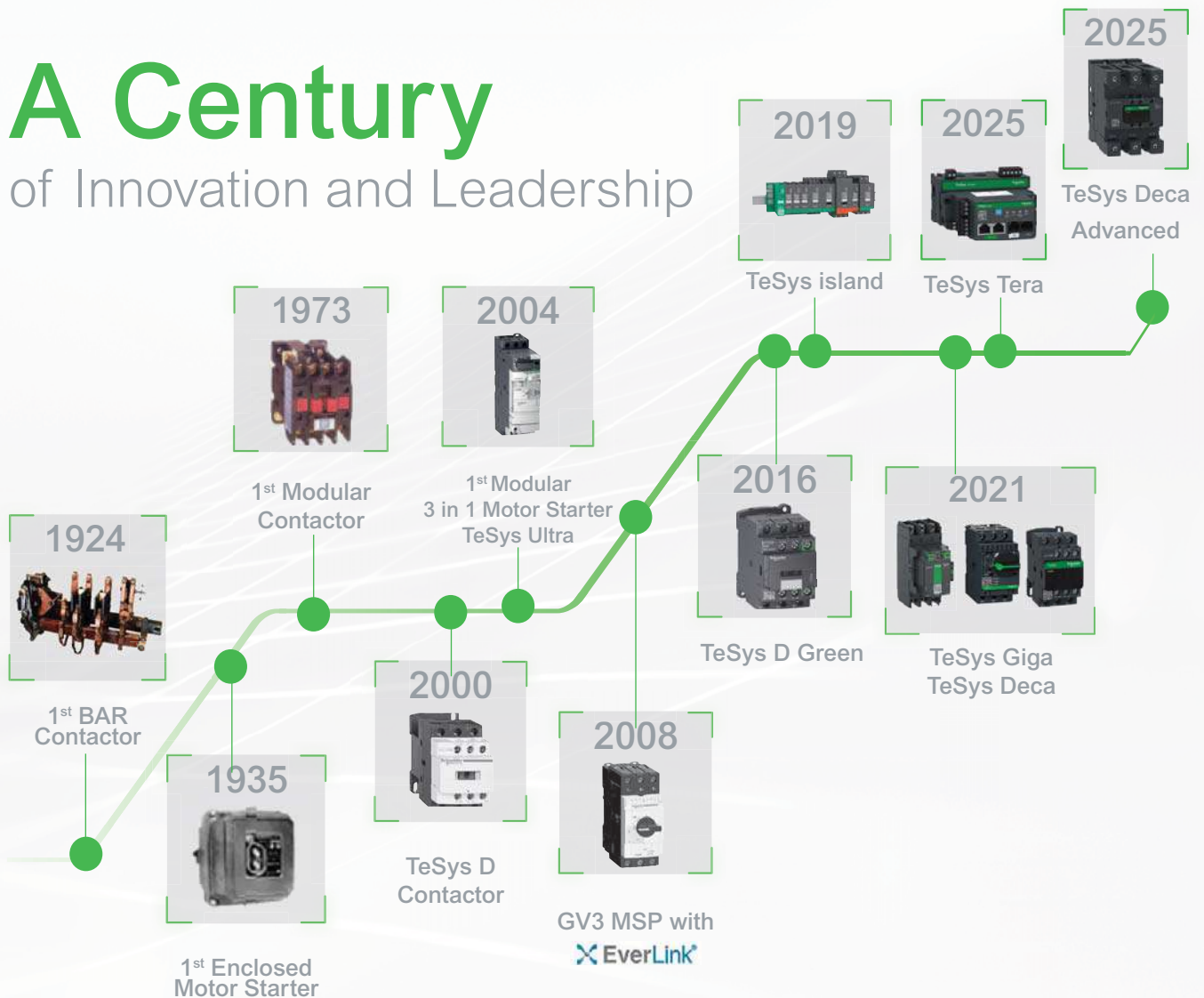

Superior safety for all industries

TeSys motor controls come with all of the isolation, protection and emergency handling you need to comply with international codes. High-contrast covers identify safety-critical devices to prevent inadvertent manual operation. Every TeSys contactor is both mechanically linked and equipped with mirror contacts for safety applications and wherever auxiliary contact state reliability is critical.



HVAC

Ensure 24/7 availability of your HVAC system with reliable products that can reach high ambient temperatures without derating.



Conveying

Decentralize the control cabinet of your conveyor line and benefit from up to 80% space reduction.



Genset

Make certain your generator starts even in the harshest conditions with robust TeSys solutions.



Pumping

Optimize single or multi-drive boosters for industry or infrastructure with energy and cost-effective solutions.



Packaging

Keep pace with the most demanding, high-end packing applications with solutions that can perform 30 million AC53a electrical cycles, like TeSys H.



Oil and Gas

Keep your employees and assets safe and improve uptime in onshore and offshore applications: pipeline operations: LNG and natural gas processing; and refining and petrochemical applications.



Water and Wastewater

Optimize the treatment and delivery of safer water by reducing energy usage and lowering operating costs.



Food and Beverage

Serve your customers with environmentally friendly products to improve sustainability, efficiency, and flexibility, allowing you to adapt to changing customer habits.

Online selection tool

EcoStruxure™ Motor Control Configurator

For Direct-On-Line and Star-Delta starters, motor circuit breakers with advanced protection, motor management relays, configurations for total coordination, drives, and soft starters.

No matter what kind of starting method you need, our online EcoStruxure™ Motor Control Starter Configurator will help you to quickly and easily select the optimal combination of components to ensure maximized motor safety, protection, and uptime.

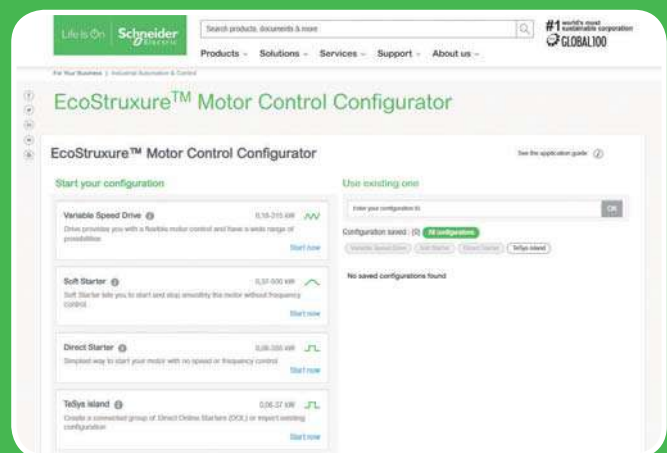

Scan or click on
the QR code

TeSys Range

TeSys Component Series Names

Series names are now grouped as per the current ratings

- Series names group conventional components (circuit breakers, contactors, relays, overcurrent relays) by current rating ranges.
 - 0 to 16 A > **TeSys K** Series
 - 9 to 150 A > **TeSys 'Deca'** Series
 - 185 to 800 A > **TeSys 'Giga'** Series.
- TeSys advanced components have a specific classification.
 - 0 to 38 A All-in-one starters > **TeSys 'Ultra'** Series
 - 0 to 80 A Motor Control/Protection/Monitoring system > **TeSys 'island'** Series.
- Other TeSys component names remain unchanged (TeSys F, TeSys B, TeSys T).

> TeSys K Series

The essential line for motors up to 7.5kW/16A direct on TeSys K series of Motor Starters



> TeSys Deca Series

The industrial standard for motors up to 75kW/150A direct on TeSys Deca series of Motor Starters



> TeSys Giga Series

For large motors up to 450kW/800A direct on TeSys Giga Series



> TeSys Ultra Series

The most compact totally coordinated solution for Motor Starters. For Direct On Line or Reversing Motor Control and Drive Protection upto 18.5kW/38 A on TeSys Ultra series



> TeSys Island Series

Digitally powered monitoring, control and protection of electrical motors up to 37kW/80 A on TeSys Island Series



TeSys Control

TeSys K

Control Relays - K Model (AC & DC Control)



- Conformance IEC, UL, CSA, CE Marking
- Inbuilt 4 auxiliary contacts
- 10A thermal rating
- Available with AC (50/60Hz Dual frequency), DC & DC low consumption coil options

No of Poles	AC Control Reference	Unit MRP [₹]				DC Control Reference ⁽⁴⁾	Unit MRP [₹]		
		B7 (24V)	F7 (110V)	M7 (220V)	N7 (415V)		BD (24V)	FD (110V)	MD (220V)
2NO + 2NC	CA2KN22*	1930	1930	1930	1930	CA3KN22**	2685	2685	2685
3NO + 1NC	CA2KN31*	-	-	1930	-	CA3KN31**	2685	2685	2685
4NO	CA2KN40*	-	1930	1930	2305				

No of Poles	DC low consumption Reference ^{(1) (2) (3)}	Unit MRP [₹]		
		BW3 (24V)	EW3 (48V)	SW3 (72V)
2NO + 2NC	CA4KN22***	3290	3950	3290
3NO + 1NC	CA4KN31***	3290	3950	-
4NO	CA4KN40***	3290	-	-

For other coil voltage ratings regarding above, please contact Schneider Electric customer care.

* Reference to be completed by adding coil voltage code

- (1) Compatible with PLC outputs
 (2) Wide range coil (0.7...1.25Uc), suppressor fitted as standard
 (3) 2 pole auxiliary contact block can be mounted additionally
 (4) Optional in-built surge suppressor available

Power Contactors - K Model (3 Pole AC & DC Control)



- Conformance to IEC, UL, CSA
- Current Rating : 6A to 16A, AC-3 duty
- 1NO or 1NC inbuilt auxiliary contact
- Available in 3P & 4P version
- Available with AC (50/60Hz Dual frequency), DC & DC low consumption⁽⁵⁾ coil options

Motor Power (kW)	Auxiliary Contacts	AC Control Reference	Unit MRP [₹]				DC Control Reference ⁽⁵⁾	Unit MRP [₹]		
			B7 (24V)	F7 (110V)	M7 (220V)	N7 (415V)		BD (24V)	FD (110V)	MD (220V)
3	1NC	LC1K0601*	1635	1635	1635	1985	LP1K0601**	2555	3085	-
	1NO	LC1K0610*	1635	1635	1635	1635	LP1K0610**	2555	3085	-
5.5	1NC	LC1K0901*	1710	1710	1710	2065	LP1K0901**	2775	2775	2775
	1NO	LC1K0910*	1710	1710	1710	1710	LP1K0910**	2775	2775	2775
7.5	1NC	LC1K1201*	1935	1935	1935	-	LP1K1201**	3220	-	-
	1NO	LC1K1210*	1935	1935	1935	2330	LP1K1210**	3220	3895	3920
10	1NC	LC1K1601*	2285	2285	2285	-	-	-	-	-
	1NO	LC1K1610*	2285	2285	2285	-	-	-	-	-

For other coil voltage ratings contactors, please contact Customer Care.

* Reference to be completed by adding coil voltage code

(5) For low consumption offer, please contact Customer Care

Reversing Contactors - K Model



- Conformance to IEC, UL, CSA, CE
- Current Rating : 6A to 16A, AC-3 duty
- 1NO or 1NC inbuilt auxiliary contact
- Available in 3P & 4P version
- Available with AC(50/60Hz Dual frequency), DC & DC low consumption⁽⁶⁾ coil options

Motor Power (kW)	Auxiliary Contacts	AC Control Reference	Unit MRP [₹]	
			F7 (110V)	M7 (220V)
3	1 NC	LC2K0601*	5440	5440
	1 NO	LC2K0610*	5440	5440
5.5	1 NC	LC2K0901*	5810	5810
	1 NO	LC2K0910*	5810	5810
7.5	1 NC	LC2K1201*	5985	5985
	1 NO	LC2K1210*	5985	5985
10	1 NC	LC2K1601*	8040	8040
	1 NO	LC2K1610*	6685	8040

For other coil voltage ratings contactors, please contact Customer Care.

* Reference to be completed by adding coil voltage code

(6) For current rating and ref please contact Customer Care

For details on non standard references, technical parameters, accessories, compatibility, stockable and non stockable status please contact Customer Care

✓ NORMAL STOCK ITEMS

W.E.F. February 03rd, 2025

TeSys Control

TeSys K

Accessories - K Model

Description	Mounting	Contacts	Reference	Unit MRP [₹]
Auxiliary contact block	Front	2NC	LA1KN02	895
	Front	1NO + 1NC	LA1KN11 <input checked="" type="checkbox"/>	820
	Front	2NO	LA1KN20	895
	Front	4NC	LA1KN04	1380
	Front	1NO + 3NC	LA1KN13	1380
	Front	2NO + 2NC	LA1KN22 <input checked="" type="checkbox"/>	1380
	Front	3NO + 1NC	LA1KN31	1380
	Front	4NO	LA1KN40	1380

Description	Control Voltage	Range	Reference	Unit MRP [₹]
On Delay Electronic Timer	24..48 V AC/DC	1..30S	LA2KT2E	4515

Description	Coil Voltage	Reference	Unit MRP [₹]
Surge Suppressor - RC Circuit	220..250V AC	LA4KA1U*	1265
Surge Suppressor - Varistor	130..250V AC/DC	LA4KE1UG*	1265
Surge Suppressor - Varistor	50..129V AC/DC	LA4KE1FC*	1265

* Lot size 5

(1) Front mounted with common point changeover contact

For details on non standard references, technical parameters, accessories, compatibility, stockable and non stockable status please contact Customer Care

NORMAL STOCK ITEMS

W.E.F. February 03rd, 2025

TeSys Capacitor Duty Contactor

Capacitor Duty Contactor



Nominal Reactive Power 440V	Auxiliary Contacts	Reference	Unit MRP [₹]	
			F7 (110 V)	M7 (220V)
LC1-D•K - with Damping Resistors & Block of Early Make poles				
12.5 kVar	1NO + 2NC	LC1DFK*	5885	5885
16.7 kVar	1NO + 2NC	LC1DGK*	8265	8265
25 kVar	1NO + 2NC	LC1DMK*	10180	10180
32 kVar	1 NO + 2NC	LC1DPK*	22180	22180
40 kVar	1NO + 2NC	LC1DTK*	30555	30555
60 kVar	1NO + 2NC	LC1DWK12*	34395	34395

For other coil voltage ratings contactors, please contact Customer Care.

* Reference to be completed by adding coil voltage code



Instruction Manual
Video for Capacitor
Duty Contactors

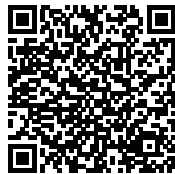

Guide for the Design
and Production of LV
Power Factor
Correction Cubicles

For complete information on selection of capacitor switching please refer to the TeSys catalogue

For details on non standard references, technical parameters, accessories, compatibility, stockable and non stockable status please contact Customer Care

NORMAL STOCK ITEMS

W.E.F. February 03rd, 2025

TeSys Control

TeSys Deca

The next-generation TeSys Deca series motor starters offer a reliable and robust solution for a faster machine time-to-market. It has a new modern look & feel and is designed to meet the requirements of Electro domestic applications. Ease of operation and reliability is guaranteed with the new multi-standard screws. Digital customer experience is enhanced with a QR embedded from product to packaging.

TeSys Deca Control Contactors (AC & DC Control)



- Conformance to IEC, UL, CSA
- 5 inbuilt auxiliary contacts, in just 2 variants
- Available with AC (50/60Hz Dual frequency), DC & DC low consumption coil options
- High Operating ambient temperature upto 60 Deg C
- Inbuilt surge suppressor for DC & DC low consumption

No of Poles	AC Control Reference	Unit MRP [₹]				DC Control Reference ⁽⁴⁾	Unit MRP [₹]		
		B7 (24V)	F7 (110V)	M7 (220V)	N7 (415V)		BD (24V)	FD (110V)	MD (220V)
3NO + 2NC	CAD32*	2065	2065	2065	2065	CAD32**	2965	2965	2965
5NO	CAD50*	2065	2065	2065	-	CAD50**	2965	2965	2965

No of Poles	DC low consumption Reference ^{(1) (2) (3)}	Unit MRP [₹]		
		BL (24V)	FL (110V)	ML (220V)
3NO + 2NC	CAD32***	3710	-	6285
5NO	CAD50***	3710	4445	-

For other coil voltage ratings contactors, please contact Customer Care.

* Reference to be completed by adding coil voltage code

(1) Compatible with PLC outputs

(2) Wide range coil (0.7...1.25Uc), suppressor fitted as standard

(3) 2 pole auxiliary block can be mounted

Power Contactors - Deca Model (3 Pole AC & DC Control)



- Conformance to IEC, UL, CSA
- Available with AC (50/60Hz Dual frequency), DC & DC low consumption coil options
- High Operating ambient temperature, no derating upto 60 Deg C
- Inbuilt 1NO + 1NC auxiliary contacts upto 150A
- High electrical and mechanical life
- Fuse-less Type 2 Co-ordination Charts available
- EverLink® terminal for 40, 50, 65 & 80A contactors
- Inbuilt surge suppressor in DC coil for 9-80A

[Ie] Rated Operational Current AC-1	kW	AC-3 Duty			Auxiliary Contacts	AC Control Reference	Unit MRP [₹]		
		HP	A				M7 (220V)	N7 (415V)	F7 (110V)
25	4	5.5	9	1 NO + 1 NC	LC1D09*	2050	2050	2050	
25	5.5	7.5	12	1 NO + 1 NC	LC1D12*	2305	2305	2305	
32	9	12.5	18	1 NO + 1 NC	LC1D18*	2675	2675	2675	
40	11	15	25	1 NO + 1 NC	LC1D25*	3325	3325	3325	
50	15	20	32	1 NO + 1 NC	LC1D32*	6465	6465	6465	
50	18.5	25	38	1 NO + 1 NC	LC1D38*	9195	9195	9195	
60	22	30	40	1 NO + 1 NC	LC1D40A*	9835	9835	9835	
80	25	35	50	1 NO + 1 NC	LC1D50A*	12755	12755	12755	
80	37	50	65	1 NO + 1 NC	LC1D65A*	17695	17695	17695	
125	45	60	80	1 NO + 1 NC	LC1D80*	26640	26640	26640	
125	45	60	95	1 NO + 1 NC	LC1D95*	28480	28480	28480	
250	59	80	115	1 NO + 1 NC	LC1D115*	35050	35050	35050	
250	80	110	150	1 NO + 1 NC	LC1D150*	43815	43815	43815	

For other coil voltage ratings contactors, please contact Customer Care.

* Reference to be completed by adding coil voltage code

For details on non standard references, technical parameters, accessories, compatibility, stockable and non stockable status please contact Customer Care

NORMAL STOCK ITEMS

W.E.F. February 03rd, 2025

TeSys Control

TeSys Deca

[le] Rated Operational Current AC-1	AC-3 Duty			Auxiliary Contacts	DC Control Reference ⁽¹⁾	Unit MRP [₹]		
	kW	HP	A			BD (24V)	FD (110V)	MD (220V)
25	4	5.5	9	1 NO + 1 NC	LC1D09*	3255	3175	3255
25	5.5	7.5	12	1 NO + 1 NC	LC1D12*	3660	3660	3660
32	9	12.5	18	1 NO + 1 NC	LC1D18*	4510	4400	4510
40	11	15	25	1 NO + 1 NC	LC1D25*	5695	5560	5695
50	15	20	32	1 NO + 1 NC	LC1D32*	11620	11340	11620
50	18.5	25	38	1 NO + 1 NC	LC1D38*	13730	13730	13730
60	22	30	40	1 NO + 1 NC	LC1D40A*	16445	-	-
80	25	35	50	1 NO + 1 NC	LC1D50A*	20640	20640	-
80	37	50	65	1 NO + 1 NC	LC1D65A*	23405	-	-
125	45	60	80	1 NO + 1 NC	LC1D80*	31785	31785	31785
125	45	60	95	1 NO + 1 NC	LC1D95*	34835	34835	34835
250	59	80	115	1 NO + 1 NC	LC1D115*	41170	41170	41170
250	80	110	150	1 NO + 1 NC	LC1D150*	49405	49405	49405

For other coil voltage ratings contactors, please contact Customer Care.
* Reference to be completed by adding coil voltage code

TeSys Deca Power Contactors (3 Pole DC Low Consumption)

Now available upto 80A with the TeSys Deca Advanced Low Consumption offer

[le] Rated Operational Current AC1	Motor Power (Long Life) AC3			Auxiliary Contacts	Reference	Unit MRP [₹]	
	kW	HP	A			BL (24V)	EL (48V)
25	4	5.5	9	1 NO + 1 NC	LC1D09****	3570	3570
25	5.5	7.5	12	1 NO + 1 NC	LC1D12****	3995	3995
32	9	12.5	18	1 NO + 1 NC	LC1D18****	6105	6105
40	11	15	25	1 NO + 1 NC	LC1D25****	7440	7440
50	15	20	32	1 NO + 1 NC	LC1D32****	12725	12725

[le] Rated Operational Current AC1	Motor Power (Long Life) AC3			Auxiliary Contacts	Reference	Unit MRP [₹]			
	kW	HP	A			BBE (24V DC)	BNE (24-60V AC/DC)	EHE (48-130V AC/DC)	KUE (100-250V AC/DC)
60	22	30	40	1 NO + 1 NC	LC1D40A#	16445	16445	16445	16445
80	25	35	50	1 NO + 1 NC	LC1D50A#	20640	20640	20640	20640
80	37	50	65	1 NO + 1 NC	LC1D65A#	23405	23405	23405	23405
80	37	50	80	1 NO + 1 NC	LC1D80A#	28405	28405	28405	28405

For other coil voltage ratings contactors, please contact Customer Care.
* Reference to be completed by adding coil voltage code

TeSys Deca Power Contactors (4 Pole AC & DC Control)



- Conformance to IEC, UL, CSA
- Available with AC (50/60Hz Dual frequency), DC & DC low consumption⁽¹⁾ coil options
- High Operating ambient temperature, no derating upto 60 deg C

[le] Rated Operational Current AC1	Poles Composition	AC control Reference	Unit MRP [₹] M7 (220V)	DC control Reference	Unit MRP [₹]		
					BD (24V)	FD (110V)	MD (220V)
20	4NO	-	-	LC1DT20**	3925	3925	3925
	2NO+2NC	-	-	LC1D098**	4275	4275	4275
25	4NO	-	-	LC1DT25**	4715	4715	4715
	2NO+2NC	-	-	LC1D128**	6155	6155	6155
32	4NO	-	-	LC1DT32**	5185	8790	6210
	2NO+2NC	-	-	LC1D188**	7010	8390	7010
40	4NO	-	-	LC1DT40**	8125	8125	8125
	2NO+2NC	-	-	LC1D258**	10710	10710	10710
60	4NO	-	-	LC1DT60A#	16260	19480	19480
	2NO+2NC	-	-	LP1D40008**	21365	25605	21365
80	4NO	-	-	LC1DT80A#	24255	24255	-
	2NO+2NC	-	-	LP1D65008**	28725	28725	-
125	4NO	-	-	LP1D80004**	31115	37280	-
	2NO+2NC	-	-	LP1D80008**	35900	43010	35900
250	4NO	LC1D1150046*	39215	LC1D1150046**	43565	43565	-

Note: Please contact Customer Care for 4 Pole AC coil contactor details

⁽¹⁾ For current rating and ref please contact Customer Care

For other coil voltage ratings contactors, please contact Customer Care.

* Reference to be completed by adding coil voltage code

For details on non standard references, technical parameters, accessories, compatibility, stockable and non stockable status please contact Customer Care

✓ NORMAL STOCK ITEMS

W.E.F. February 03rd, 2025



TeSys Deca Advanced

The Revolutionary Electronic Coil Contactor



Complete range in 4 frame sizes:

09-12-18A

25-32-38A

40-50-65-80A

115-150A **NEW**

 -80%

Up to 80% less energy consumption than a traditional electromechanical motor starter

10X Reduction
in references

Only 3 references to cover the complete voltage range for AC and DC

 -35%

Highest currents in smallest size, e.g.

PLC Compatible

Direct connection to a PLC without the need for an interposing relay

SEMIF47

High uptime thanks to wide band coil with high resistance to voltage surges/SEMIF47 conform



Scan to see TeSys Deca Advanced under voltage performance.

TeSys Control

Deca Advanced Contactors

Introduction

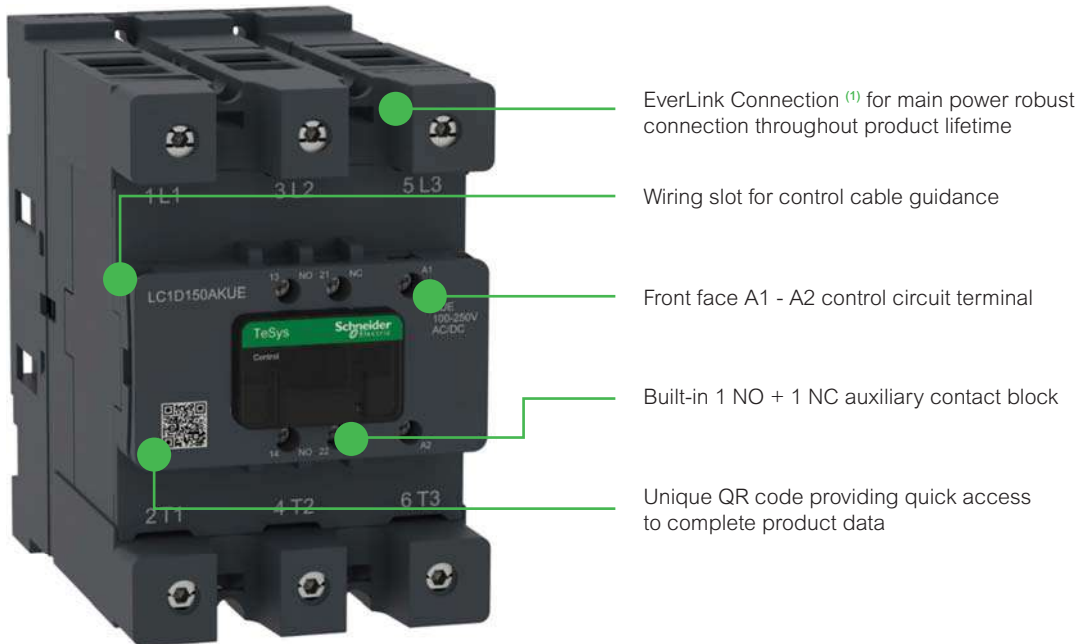

TeSys Deca Advanced contactors



9...18 A



25...38 A



40...80 A



115...150 A

Power & switch

- 3 or 4 power poles
- 9 to 150 A (AC-3/AC-3e)
- 25 to 200 A (AC-1)
- Embedded 1 NO + 1 NC auxiliary contacts
- Patent EverLink main power terminals ⁽¹⁾

Efficient design

- Low consumption coils
- High rating within compact size
- Ready for IE3/IE4 high efficiency motor

Remote control

- 24V DC ⁽²⁾, 24...60 V, 48...130 V 100...250 V, 200...500 V AC/DC coils
- PLC direct control available ⁽³⁾
- High resistance to voltage fluctuation
- Embedded surge suppressor

Standards & Certifications

- Multiple standards
- International certifications

⁽¹⁾ for LC1D40A...150A

⁽²⁾ BBE coil for LC1D40A...80A for PLC direct input

⁽³⁾ BNE coil for LC1D09...38, BBE coil for LC1D40 A...80A

TeSys Control

Deca Advanced Contactors

TeSys Deca Advanced Contactors



LC1

Contactor

TeSys Deca
Advanced
series, 3P

D

09

AC3 Rating

09: 09 A
12: 12 A
18: 18 A
25: 25 A
32: 32 A
38: 38 A
40: 40 A
50: 50 A
65: 65 A
80: 66 A
115: 115 A
150: 150 A

NEW
NEW

A(6)

Main Terminal

Blank: Screw
A: EverLink
+6: Lug

KUE

Coil voltage (AC/DC)

BBE⁽¹⁾: 24 V DC
BNE: 24...60 V AC/DC
EHE: 48...130 V AC/DC
KUE: 100...250 V AC/DC
LSE⁽²⁾: 200...500 V AC/DC

(1) BBE only for LC1D40A...D80A
(2) LSE only for LC1D115A...D150A

LC1

Contactor

TeSys Deca
Advanced
series, 4P

DT

200

AC3 Rating

60: 60 A
80: 80 A
200: 200 A

NEW

A(6)

Main Terminal

A: EverLink
+6: Lug

KUE

Coil voltage (AC/DC)

BBE⁽³⁾: 24 V DC
BNE: 24...60 V AC/DC
EHE: 48...130 V AC/DC
KUE: 100...250 V AC/DC
LSE⁽⁴⁾: 200...500 V AC/DC

(3) BBE only for LC1DT60A...DT80A
(4) LSE only for LC1DT200A

TeSys Control

Deca Advanced Contactors

TeSys Deca Advanced Contactor (3 Pole AC/DC Universal Coil)



- Universal AC/DC coil from 24 - 250V
- Special low consumption offer from 40-80A
- Fuseless Type 2 Co-ordination charts available

The Revolutionary Electronic Coil Contactor

[le] Rated Operational Current AC1	AC3 Duty (Long Life)			Auxiliary Contacts	Reference	Unit MRP [₹]			
	kW	HP	A			BNE (24-60V AC/DC)	EHE (48-130V AC/DC)	KUE (100-250V AC/DC)	LSE (200-250V AC/DC)
25	4	5.5	9	1 NO + 1 NC	LC1D09	4240	4240	4240	-
25	5.5	7.5	12	1 NO + 1 NC	LC1D12	4395	4395	4395	-
32	9	12.5	18	1 NO + 1 NC	LC1D18	5800	5800	5800	-
40	11	15	25	1 NO + 1 NC	LC1D25	6925	-	6925	-
50	15	20	32	1 NO + 1 NC	LC1D32	14070	14070	14070	-
50	18.5	25	38	1 NO + 1 NC	LC1D38	15180	18035	15180	-
60	22	30	40	1 NO + 1 NC	LC1D40A	16445	16445	16445	-
80	25	35	50	1 NO + 1 NC	LC1D50A	20640	20640	20640	-
80	37	50	65	1 NO + 1 NC	LC1D65A	23405	23405	23405	-
60	37	50	80	1 NO + 1 NC	LC1D80A	28405	28405	28405	-
80	22	30	40	1 NO + 1 NC	LC1D40A	16445	16445	16445	-
80	25	35	50	1 NO + 1 NC	LC1D50A	20640	20640	20640	-
80	37	50	65	1 NO + 1 NC	LC1D65A	23405	23405	23405	-
250	59	80	115	1 NO + 1 NC	LC1D115A NEW	38035	39695	39445	40610
250	80	110	150	1 NO + 1 NC	LC1D150A NEW	40445	41610	41245	42415

For other coil voltage ratings contactors, please contact Customer Care.

* Reference to be completed by adding coil voltage code

TeSys Deca Advanced Power Contactors (4 Pole AC & DC Control)

[le] Rated Operational Current AC-1	Poles Composition	Auxiliary Contacts	AC & DC Control Reference	BBE (24V DC only)	Unit MRP [₹]			
					BNE (24-60V AC/DC)	EHE (48-130V AC/DC)	KUE (100-250V AC/DC)	LSE (200-250V AC/DC)
60	4NO	1NO + 1NC	LC1DT60A	16260	16260	16260	16260	-
80	4NO	1NO + 1NC	LC1DT80A	24255	24255	24255	24255	-
200	4NO	1NO + 1NC	LC1DT200A NEW	-	47305	50547	50183	52826

Coil Voltage Code

Type	Voltage	24-60V AC/DC	48-130V AC/DC	100-250V AC/DC	200-250V AC/DC
AC/DC*	LC1D09 - D38, LC1D40A - 80A, LC1DT60A - 80A	BNE	EHE	KUE	
	LC1D115A - 150A NEW	BNE	EHE	KUE	LSE
24V DC Low Consumption*	LC1D40A - 80A, LC1DT60A - 80A	BBE (24V DC only)		-	-

For other coil voltage ratings contactors, please contact Customer Care.

* Reference to be completed by adding coil voltage code



Check the features of the TeSys Deca Advanced

For details on non standard references, technical parameters, accessories, compatibility, stockable and non stockable status please contact Customer Care

NORMAL STOCK ITEMS

W.E.F. February 03rd, 2025

TeSys Control

Deca Advanced Contactors

Introduction

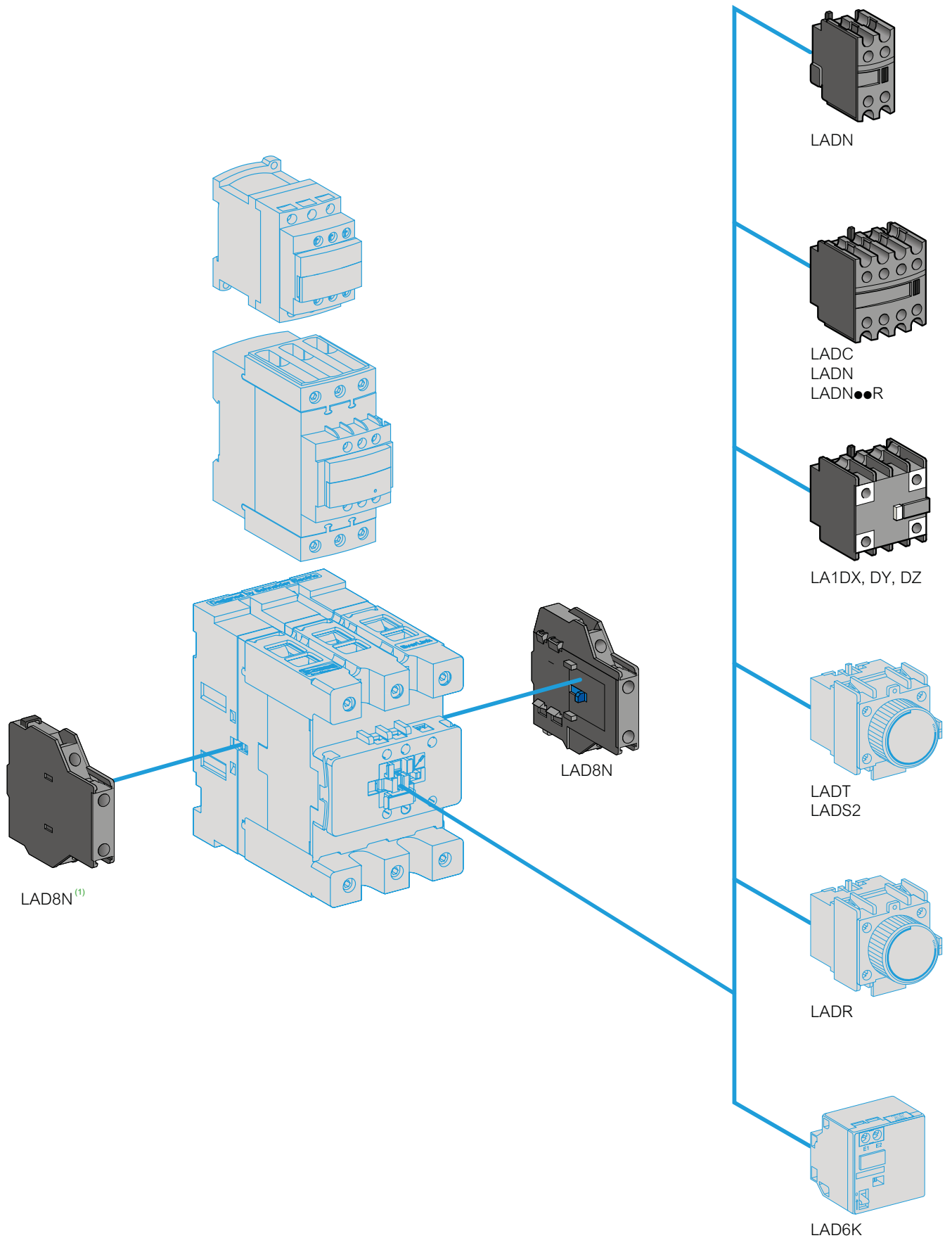

(1) No left side mounting on Deca Advanced contactors up to LC1D38.

TeSys Control

TeSys Deca

Description	For use with	Reference	Unit MRP [₹]
Power connection accessories			
Terminal block	For supply to one or more GV2 G busbar sets	GV1G09	2585
Set of 63A busbars for parallelling of contactors	2 contactors LC1D09...D18 or D25...D38	GV2G245	2515
	4 contactors LC1D09...D18 or D25...D38	GV2G445	3955
Set of 115A busbars for parallelling of contactors	2 contactors LC1D40A...D80A	GV3G264	4520
	3 contactors LC1D40A...D80A	GV3G364 ⁽¹⁾	2415
Set of S-shape busbars	For circuit breakers GV3P** & GV3L** and contactors LC1 D40A...D65A	GV3S	1810

**Not applicable for GV3P/GV3L 73A and 80A



GV2G245



GV1G09

Description	For use with	Reference	Unit MRP [₹]
Mechanical interlock	LC1D09 to D38(1)	LAD9V2	920
	LC1D40A to D65A(1)	LAD4CM	1870
	LC1D80 and D95 (for AC control voltage)	LA9D4002	4100
	LC1D80 and D95 (for DC control voltage)(2)	LA9D8002	6105
	LC1D115 and D150(2)	LA9D11502	6190

(1) With this set of busbars, any one contactor can be supplied directly by its EverLink® double cage power terminal block. The other two contactors are supplied by the busbar set. The 115A limitation is therefore applied to these two contactors.
 (2) With electrical interlock

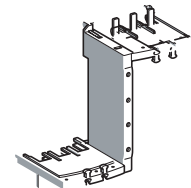

GV3S

Description	For use with	Reference	Unit MRP [₹]
Power Connection for Reversing			
Kit Comprising :	LC1D09 to D38	LAD9V5	765
1. A set of parallel bars	LC1D09 to D38	LAD9V6	955
2. A set of reverser bars.	LC1D40A to D80A	LA9D65A69	3980
	LC1D80 and D95 (for AC control voltage)	LA9D8069	8520
	LC1D80 and D95 (for DC control voltage)	LA9D8069	8520
	LC1D115 and D150	LA9D11569	14175

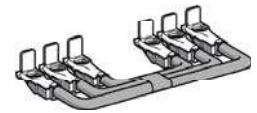
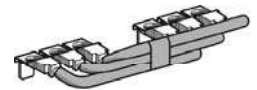

LA9 D8069

Description	For use with	Reference	Unit MRP [₹]
Reversing Kit			
Kit Comprising :			
1. A mechanical interlock LAD 9V2 with electrical interlocking LAD 9V1	LC1D09 to D38	LAD9R1V	1915
2. A set of power connections LAD 9V5 (parallel) and LAD 9V6 (reversing).			
Kit Comprising :			
1. A mechanical interlock LAD 9V2 without electrical interlocking	LC1D09 to D38	LAD9R1	1910
2. A set of power connections LAD 9V5 (parallel) and LAD 9V6 (reversing).			
Kit Comprising :			
1. A mechanical interlock LAD 4CM	LC1D40A to D80A	LAD9R3	4545
2. A set of power connections LA9 D65A69.			

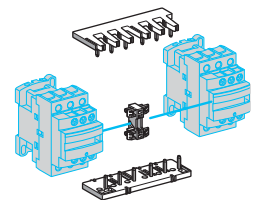

LAD9R1

Description	For use with	Reference	Unit MRP [₹]
Star Delta Kit			
Time delay contact block LAD S2 (LC1D09...D80),	LC1D09 and D12	LAD91217	7190
Power circuit connections (LC1D09...D80),	LC1D18 to D32	LAD93217	9245
Hardware required for fixing the contactors onto the mounting plate (LC1D80)	LC1D40A and D50A	LAD9SD3	18680
	LC1D80	LA9D8017	20745

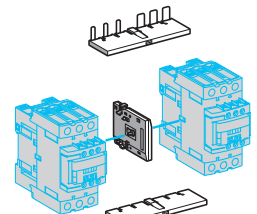

LAD9R3



LAD91217



LAD9SD3



LA9D8017

For details on non standard references, technical parameters, accessories, compatibility, stockable and non stockable status please contact Customer Care

✓ NORMAL STOCK ITEMS

W.E.F. February 03rd, 2025

TeSys Control

TeSys Deca

Description	Time Delay Range	Timer Type	Reference	Unit MRP [₹]
On delay timer ^{(1) (2)}	15...30 s	on delay	LA4DT2U	6935
On delay timer ^{(1) (2)}	0.1...2 s	on delay	LA4DT0U	6935
On delay timer ^{(1) (2)}	25...500 s	on delay	LA4DFB	6390
Relay interface module - 24V DC ^{(1) (2)}	-	-	LA4DT4U	7770

(1) For LC1 D09...38A (3P, AC coils only) add mounting adaptor LAD4BB and for LC1 D40A...65A (3P, AC coils only), add mounting adaptor LAD4BB3.

(2) For LC1D80...150 (3P), direct mounting, for 100-250V AC Coils only.

Description	For use with	Reference	Unit MRP [₹]				
			B (24V) (AC/DC)	E (42/48V) (AC/DC)	F (110/127V) (AC/DC)	M (220/240V) (AC/DC)	Q (380/415V) (AC/DC)
TeSys Deca Model Mechanical Latch Blocks							
Front, Clip-on	LC1D09...D38 (a or c) LC1DT20...DT40 (a or c) LC1D40A...D65A (3P a or c) LC1DT60A and DT80A (4P a or c)	LAD6K10*	8335	8335	8335	8335	-
	LC1D80...D150 (3P a) LC1D80 and D115 (3 P c) LC1D80 (4 P a) LC1D80 and D115 (4 P a) LP1D80 and LC1D115 (4 P c)	LA6DK20*	8700	9760	9760	8700	13710

* Reference to be completed by adding coil voltage code and recommended to check availability with Customer Care team

Spare Coils TeSys Deca Model

Product Compatibility	Reference
AC Coils	
CAD, LC1-D09...D38, DT20..40	LXD1*
LC1D40A, D50A, D65A & LC1DT60A, DT80A	LXD3*
D80 & D95 (3P & 4P)	LX1D6*
LC1-D115, D150	LX1D8*
DC Coils	
LC1-D80-D95	LX4D7**
LC1-D115, D150	LX4D8**

* Reference to be completed by adding coil voltage code and recommended to check availability with Customer Care team

Coil Voltage Code

Type	Voltage (V)	24	110	220	415
AC*	CAD, LC1-D09...D38, DT20..40, LC1 - D150, LC1D40A, D50A, D65A & LC1DT60A, DT80A, LC1D150 LC1D80, D95, D115	B7	F7	M7	N7

For details on non standard references, technical parameters, accessories, compatibility, stockable and non stockable status please contact Customer Care

NORMAL STOCK ITEMS

W.E.F. February 03rd, 2025

Accessories

Description	For use With	Contacts	Reference	Unit MRP [₹]
Add On Blocks				
Additional instantaneous auxiliary contact blocks	LC1D09 ...LC1D150*	Front Mounted 1NO + 1NC	LADN11	615
		Front Mounted 2NO	LADN20 ✓	615
		Front Mounted 2NC	LADN02	985
		Front Mounted 2NO + 2NC	LADN22 ✓	1120
		Front Mounted 4NC	LADN04	1630
		Front Mounted 4NO	LADN40 ✓	1120
		Front Mounted 1NO + 3NC	LADN13	1120
		Front Mounted 3NO + 1NC	LADN31 ✓	1120
	LC1D80..LC1D95	Front Mounted 1NO	LADN10	545
		Front Mounted 1NC	LADN01	545

Description	Contacts	Reference	Unit MRP [₹]
Add On Blocks			
Additional instantaneous auxiliary contact blocks	Side Mounted ⁽¹⁾ 1NO + 1NC	LAD8N11	2345
	Side Mounted ⁽¹⁾ 2NO	LAD8N20	2345
Pneumatic timer blocks front mounted	ON delay 1NO + 1NC 0.1..3s	LADT0	4445
	ON delay 1NO + 1NC 0.1..30s	LADT2	4445
	ON delay 1NO + 1NC 10..180s	LADT4	4445
	ON delay 1NO + 1NC 1..30s (2)	LADS2 ✓	4745
	OFF delay 1NO + 1NC 0.1 ..3s	LADR0	4445
	OFF delay 1NO + 1NC 0.1 ..30s	LADR2 ✓	4445
	OFF delay 1NO + 1NC 10..180s	LADR4	4445

(1) Suitable for mounting on TeSys Deca range AC Coil Contactors and Control Relays only

(2) With Switching time of 40 ms between opening of the NC contact and closing of the NO contact recommended for Star - Delta Starters

Accessories compatibility

Contactors		Instantaneous Auxiliary Contacts				Time delay Front Mounted	
Type	Number of Poles and Size	Side mounted	Front mounted				
			1 contact	2 contact	4 contacts		
AC & AC/DC	3P LC1D09...D38	1 on LH side	and	-	1	or 1	or 1
AC & AC/DC	3P LC1D40A...D80A	1 on LH or 1 on RH side	and	-	1	or 1	or 1
AC & AC/DC	3P LC1D80 and D95A (50/60 Hz)	1 on each side	or	2	and 1	or 1	or 1
AC & AC/DC	3P LC1D80 and D95A (50 or 60 Hz)	1 on each side	and	2	and 2	or 1	or 1
AC & AC/DC	3P LC1D115 and D150	1 on LH side	and	-	1	or 1	or 1
AC & AC/DC	4P LC1DT20...DT40	1 on LH side	and	-	1	or 1	or 1
AC & AC/DC	4P LC1DT60A and DT80A	1 on LH or 1 on RH side	and	-	1	or 1	or 1
AC & AC/DC	4P LC1D40008, D65008 and D80	1 on each side	or	1	or 1	or 1	or 1
AC & AC/DC	4P LC1D115	1 on each side	and	1	or 1	or 1	or 1
DC	3P LC1D09...D38	-	-	-	1	or 1	or 1
DC	3P LC1D40A...D80A	-	-	-	1	or 1	or 1
DC	3P LC1D80 and D95	-	-	1	or 1	or 1	or 1
DC	3P LC1D115 and D150	1 on LH side	and	-	1	or 1	or 1
DC	4P LC1DT20...DT40	-	-	-	1	or 1	or 1
DC	4P LC1DT60A and DT80A	-	-	-	1	or 1	or 1
DC	4P LC1D40008, D65008 and D80	-	-	2	and 1	or 1	or 1
DC	4P LC1D115	1 on each side	-	-	and 1	or 1	or 1
LC ⁽³⁾	3P LC1D09...D38	-	-	-	1	-	-
LC ⁽³⁾	3P LC1DT20...DT40	-	-	-	1	-	-

(3) LC : Low consumption

For details on non standard references, technical parameters, accessories, compatibility, stockable and non stockable status please contact Customer Care

✓ NORMAL STOCK ITEMS

W.E.F. February 03rd, 2025

TeSys Control

TeSys Deca

Accessories

Description	For use with	Reference	Unit MRP [₹]
For Contactor D115/150			
Contacts set - 3P	LC1D115	LA5D1158031	27305
Contacts set - 3P	LC1D150	LA5D150803	28305
Contacts set - 4P	LC1D1150046	LA5D115804	37635

Product Compatibility	Fixing	Control Circuit Voltage	Suppressor Type	Reference	Unit MRP [₹]
Coil Suppressor Modules					
LC1D12...D25 (4P)	Screw	110...240V AC	RC Circuit AC	LA4DA1U	2140
	Screw	12...250V DC	Diode DC	LA4DC1U	2395
LC1D09...D38, LC2D09...D38, LC1DT20...DT40, LC2DT20...DT40 (3P)	Screw	24...48V AC	Varistor AC/DC	LAD4VE	2075
	Screw	24...48V AC 400Hz	RC Circuit AC	LAD4RCE	2075
	Screw	50...127V AC 200Hz	RC Circuit AC	LAD4ROG	1875
CAD	Screw	110...240V AC 100Hz	RC Circuit AC	LAD4RCU <input checked="" type="checkbox"/>	2075
	Screw	110...250V AC	Varistor AC/DC	LAD4VU	2075
LC1D80, LC1D95, LC2D80, LC2D95 (3P) LC2D80 (4P), LC1D40008, LC1D65008	Screw	24...250V DC	Diode DC	LA4DC3U	2140
	Screw	110...250V AC	Varistor AC/DC	LA4DE2U	2045
	Screw	24...48V AC 400Hz	RC Circuit AC	LA4DA2E	2045
	Screw	50...127V AC 200Hz	RC Circuit AC	LA4DA2G	3225
	Screw	110...240V AC 100Hz	RC Circuit AC	LA4DA2U	2140
	Screw	380...415V AC 150Hz	RC Circuit AC	LA4DA2N	3225
	Screw	24...48V DC	Varistor AC/DC	LA4DE3E	2140

For details on non standard references, technical parameters, accessories, compatibility, stockable and non stockable status please contact Customer Care

NORMAL STOCK ITEMS

W.E.F. February 03rd, 2025

TeSys Control

TeSys Deca

Accessories

TeSys Deca auxiliary contact blocks for use in harsh industrial environment

Product references:
coding principle

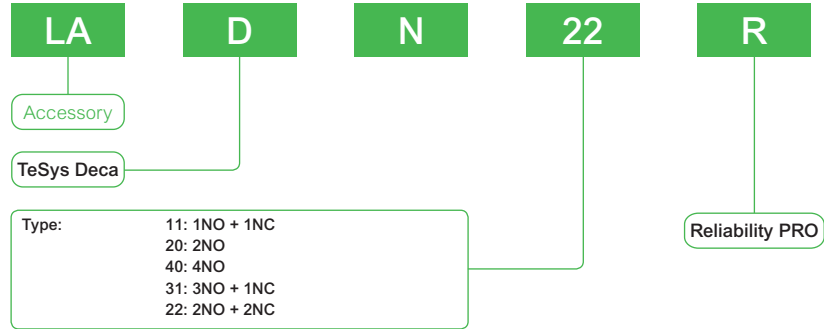

Note: There are differences in NO/NC position between LADN••R and LADN••. Please refer to page A1/42 for wiring diagram details. This auxiliary module only supports the installation on contactors with standard power consumption.

Product core values

Dustproof, Ultra-fine grain silver contacts, Improved Reliability, 17 V/1 mA

New upgrade, with innovative design



- 20% stability increased on contacts**
Improves contact reliability between mobile and static contacts
 - Fully sealed design benefits on reduced dust access**
Comprehensive blocking of dust and external pollution
 - 5X granularity refinement on silver alloy**
Innovative binary alloy refinement process provides precise conduction for each operation
 - 10⁻⁸ level on reliability**
- Capacity 17 V/1 mA

Target industries and applications

- For elevator, textile machinery and other harsh industrial applications
- For low voltage and low current high sensitive applications

Product variants:



LADN••R for harsh environment 17 V/1 mA

Description	Reference	Unit MRP [₹]
Auxiliary module 1NO + 1NC, screw terminals	LADN11R	990
Auxiliary module 2NO, screw terminals	LADN20R	1000
Auxiliary module 2NO + 2NC, screw terminals	LADN22R	1185
Auxiliary module 3NO + 1NC, screw terminals	LADN31R	1185
Auxiliary module 4NO, screw terminals	LADN40R	1200

For details on non standard references, technical parameters, accessories, compatibility, stockable and non stockable status please contact Customer Care

NORMAL STOCK ITEMS

W.E.F. February 03rd, 2025

TeSys Control

TeSys Deca

Modular marking system simplifies identification of standard contactors in the control panel to enhance visibility of the safety chain

Simple, customisable modular marking system

Standard TeSys Deca contactors

Easy-to-attach covers:



Auxiliary blocks with safety chain identification also available for more contact points:



Flexibility to customise contactors included in the safety chain during panel building



Simpler and faster maintenance with 100% visibility



Safety covers and auxiliary blocks prevent screwdriver contact with poles

Standard TeSys Ultra motor starters

Translucent labels to identify safety-chain devices:



Complete safety-chain identification system

TeSys Deca range

Retrofit contactor safety covers



LAD9ET1S
9A upto 65A



LAD9ET3S
80A to 95A



LAD9ET4S
110A to 150A



LADN22S
2NO + 2NC

Also available for CAD32/CAD50

TeSys Ultra range

Retrofit identification label



LU9ET1S

Built in Safety

TeSys Ultra motor starters are certified according to IEC 60947-4-1 for safety applications thanks to integrated mirror contact

Description	For use with	Reference	Unit MRP [₹]
Red Cover (For safety chain indication)	LC1D09...D65A and DT20 .. DT80A	LAD9ET1S	885
Auxiliary Contact block with red front face- for safety chain indication	2NO + 2NC	LADN22S	1260

For details on non standard references, technical parameters, accessories, compatibility, stockable and non stockable status please contact Customer Care

NORMAL STOCK ITEMS

W.E.F. February 03rd, 2025



TeSys Giga - Future Ready

A New Generation Series with Digital Innovation

TeSys Giga is new range of high-power contactors that supports industry requirements with process performance monitoring through data networks and online expert services.

Optimized Predictive Maintenance through-

- Continuous local and remote monitoring of contact wear
- Replaceable contacts (when necessary), facilitated by diagnostic visual indicator.

Unique Design-

- Innovative design and feature with compact size
- Ergonomic design & Flexibility in connections.
- Embedded auxiliary contact blocks
- Wideband electronic coils



TeSys Control

TeSys Giga

TeSys Giga High Power Contactors

Both "Standard" & "Advanced" versions available in 3 sizes, covering several ratings



Standard Version

Power & control

- 3 or 4 power poles
- 115 to 800A (AC-3)
- 200 to 1050A (AC-1)
- Embedded 1 NO + 1 NC auxiliary contacts
- Push-in type terminals for coils & control

Remote control

- 48-130V, 100-250V AC/DC coils
- Wide voltage range coils (direct coil control)
- Embedded surge-suppressor

Diagnostic

- Embedded wear diagnostic
- Embedded control voltages diagnostic
- Self diagnosis function
- Local alarm signaling (LED)



Advanced Version

Advanced diagnostic features along with standard version -

Diagnostic

- Remote wear diagnostic signaling kit (accessory)

Mounting

- Cable memory' adapter enables maintenance without removing power cables and busbar connections.

Remote control

- 24-48 V, 200-500 V AC/DC coils
- Digital control input (PLC output digital coil control)

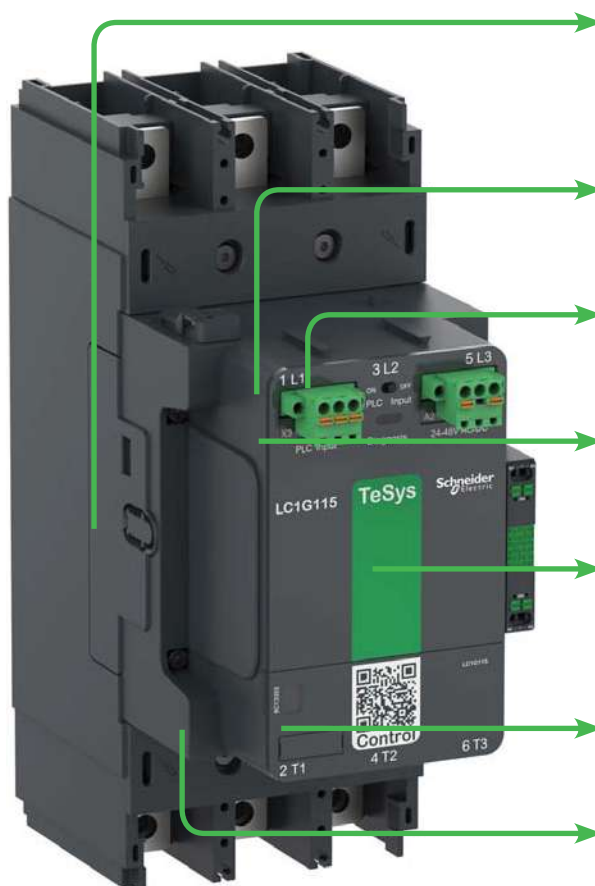

Interlock location, with knock-out cover

On/Off switch for PLC input

Push-in type control terminals enabling quick wiring and assembly

Diagnosis LED for contact wear & voltage abnormality

Built-in 1 NO + 1 NC auxiliary contact block

Unique QR code providing quick access to complete product data

Mechanical indicator for contactor open and closed status

TeSys Control

TeSys Giga

Quick & Easy Replacement of TeSys F with TeSys Giga Contactors with Retrofit Bases



Description	Reference	Unit MRP [₹]
Substitutes LC1F115-225 with LC1G115-225	LA9GRFB1	On Request
Substitutes LC1F265-500 with LC1G265-500	LA9GRFB2	On Request
Substitutes LC1F630-800 with LC1G630-800	LA9GRFB3	On Request



- Suitable for 3 pole contactors
- The bases come in two frame sizes.
- Upgrade your system with the new range of contactors in just 3 simple steps:

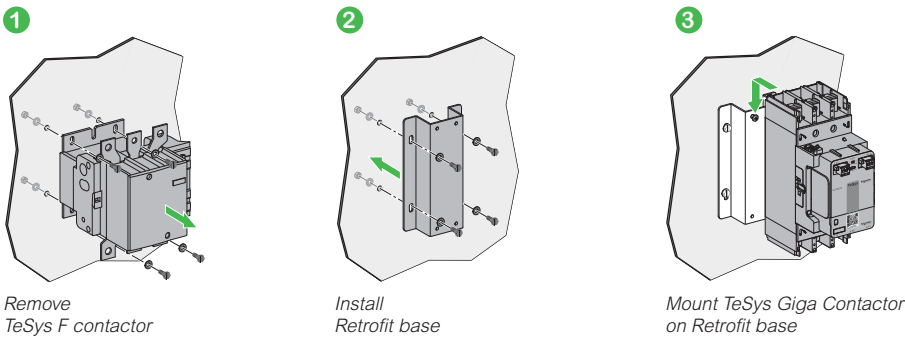

TeSys Giga Power Contactors (3 Pole AC/DC)

[Ie] Rated Operational Current AC-1	Motor Power (Long Life) AC-3		Standard version Reference	Unit MRP [₹]	
	kW (@115V)	A		EHEN (48-130 V)	KUEN (100-250 V)
250	55	115	LC1G115****	32934	34065
275	75	150	LC1G150****	43438	43438
305	90	185	LC1G185****	53834	53834
330	110	225	LC1G225****	57931	57931
385	132	265	LC1G265****	71204	71204
440	160	330	LC1G330****	86104	86104
550	200	400	LC1G400****	104067	104067
700	250	500	LC1G500****	144367	144367
1050	375	630	LC1G630****	On Request	On Request
1050	450	800	LC1G800****	On Request	On Request

TeSys Giga Power Contactors (4 Pole AC/DC)

[Ie] Rated Operational Current AC-1	Power Pole Composition	Standard version Reference	Unit MRP [₹]	
			EHEN (48-130 V)	KUEN (100-250 V)
250	4 NO	LC1G1154****	53875	53875
275	4 NO	LC1G1504****	64100	64100
305	4 NO	LC1G1854****	80095	80095
330	4 NO	LC1G2254****	94085	94085
385	4 NO	LC1G2654****	105190	105190
440	4 NO	LC1G3304****	122420	122420
550	4 NO	LC1G4004****	152140	152140
700	4 NO	LC1G5004****	224205	224205
1050	4 NO	LC1G6304****	On Request	On Request
1050	4 NO	LC1G8004****	On Request	On Request

Note:
 For ordering advanced version replace **N** with **A** in reference as EHEN/KUEN → EHEA/KUEA respectively.
 Example: LC1G1154 EHEN → LC1G1154 EHEA.
 For other coil voltage ratings contactors, please contact Customer Care.
 * Reference to be completed by adding coil voltage code

For details on non standard references, technical parameters, accessories, compatibility, stockable and non stockable status please contact Customer Care

✓ NORMAL STOCK ITEMS

W.E.F. February 03rd, 2025

TeSys Control

TeSys Giga

Giga High power contactors – Power wiring accessories

Product references

Power Terminals

Spreader Kits



Description	Suitable for	Compatible with Contactors	Increase of Pole Pitch	Quantity Set of	Reference	Unit MRP [₹]
Spreader kits	3P	LC1G115...LC1G225	35 to 45 mm	3	LA9G3611	On Request
	3P	LC1G265...LC1G500	45 to 70 mm	3	LA9G3612	On Request
	4P	LC1G115...LC1G225	35 to 45 mm	4	LA9G4611	On Request
	4P	LC1G265...LC1G500	45 to 70 mm	4	LA9G4612	On Request

Terminal extensions for larger power connections



Description	Suitable for	Compatible with Contactors	Power Connection Size	Quantity Set of	Reference	Unit MRP [₹]
Terminal connections	3P	LC1G400...LC1G500	50 mm width	3	LA9G3613	On Request
	3P	LC1G630...LC1G800	80 mm width	3	LA9G3614	On Request
	4P	LC1G400...LC1G500	50 mm width	4	LA9G4613	On Request
	4P	LC1G630...LC1G800	80 mm width	4	LA9G4614	On Request

Power Terminal Accessories

Phase Separators



Description	Suitable for	Compatible with Contactors	Quantity Set of	Reference	Unit MRP [₹]
Phase separators ⁽¹⁾	3P	LC1G115...LC1G800	2	LA9G3801	On Request
	4P	LC1G115...LC1G800	3	LA9G4801	On Request
	3P – with 50/80 mm spreaders	LC1G400...LC1G800	2	LA9G3803 ⁽²⁾	On Request
	4P – with 50/80 mm spreaders	LC1G400...LC1G800	3	LA9G4803 ⁽³⁾	On Request

(1) Either phase separators or terminal shrouds can only be mounted. Phase separators or terminal shrouds are mandatory for operational voltage, $U_e \geq 690$ V.

(2) To be used with LA9G3613 and LA9G3614.

(3) To be used with LA9G4613 and LA9G4614.

For details on non standard references, technical parameters, accessories, compatibility, stockable and non stockable status please contact Customer Care

NORMAL STOCK ITEMS

W.E.F. February 03rd, 2025

TeSys Control

TeSys Giga

Accessories

Description	Terminal Type	Position	Contacts	Reference	Unit MRP [₹]
Add On Blocks	Push In				
	1st left or 1st right	Side Mounted ⁽¹⁾	1 NO+1NC	LAG8N113P	1540
Auxiliary contact module	1st left or 1st right	Side Mounted	2 NO	LAG8N203P	1990
	2nd left or right	Side Mounted	1 NO+1NC	LAG8N113	1540
	2nd left or right	Side Mounted	2 NO	LAG8N203	1990

(1) Always supplied with TeSys Giga LC1G contactors, fitted to the right side lateral face.

Accessories

For Use With Contactor	Reference	Unit MRP [₹]
Mechanical interlock between contactors ⁽¹⁾		
Between Identical contactor frames	LA9G970	2800
Between LC1G(265-500) and LC1G(185-225)	LA9G971	2800
LC1G630 to LC1G800 and LC1G265 to LC1G500	LA9G972	On Request*

(1) Maximum 3 auxiliary contacts can be installed between 2 contactors with mechanical interlock kit.

Spare Control Module



- Wide band electronic control
- 24 V...500 V 50/60 Hz or DC control input
- Advanced and standard versions
- Accessible from the front for easy and quick replacement

Pole Composition	Control modules for Standard contactors	Reference	Unit MRP [₹]	
			EHEN (48-130V)	KUEN (100-250V)
3-Pole	LC1G115...LC1G225	LX1G3Q*	On Request	On Request
3-Pole	LC1G265...LC1G330	LX1G3R*	On Request	On Request
3-Pole	LC1G400...LC1G500	LX1G3S*	On Request	On Request
3-Pole	LC1G630...LC1G800	LX1G3T*	On Request	On Request
4-Pole	LC1G115...LC1G225	LX1G3Q*	On Request	On Request
4-Pole	LC1G265...LC1G330	LX1G3R*	On Request	On Request
4-Pole	LC1G400...LC1G500	LX1G3S*	On Request	On Request
4-Pole	LC1G630...LC1G800	LX1G3T*	On Request	On Request

For other coil voltage ratings regarding above, please contact Schneider Electric customer care.

* Reference to be completed by adding coil voltage code

For details on non standard references, technical parameters, accessories, compatibility, stockable and non stockable status please contact Customer Care









NORMAL STOCK ITEMS

W.E.F. February 03rd, 2025

TeSys Protection Range

TeSys has the most rugged and reliable solution to manage motors

Please find a quick range overview below

	TeSys Power		TeSys Protect				TeSys Active		
Feature	Motor Protection Circuit Breakers		Overload Relays	Multi function Relays		TeSys Ultra	TeSys T	TeSys Island	
TeSys Range of Products	GV2P, GV4P GV3P, GV2ME	GV4PEM	LR2K, LRD, LR9D, LR9F	LR9G	EOCR				
									
Short circuit									
Causes of overheating									
Slight overload									
Locked rotor									
Ventilation fault With probes							With Probes	With Probes	
Abnormal temperature rise								With Probes	
Shaft bearing seizure									
Insulation fault						With CBCT			
Long starting time Adjustable Adjustable		Adjustable				Adjustable	Adjustable	Adjustable	
Heavy duty			LR9D only						
Voltage variation (Derived)									
Causes of phase variation									
Phase reversal									
Phase losses									
Phase imbalance									
Earth fault									
Historic fault, Pre-Alarming					Possible Pre alarm				



Protection Relays for Motor Safety

Providing motor safety tailored to your needs



TeSys Protect

TeSys K, TeSys Deca, TeSys F, TeSys Giga

Thermal Overload Relays - TeSys K Series (Direct Mounting)



- Conformance to IEC, UL, CSA, CE
- Range : 0.1A to 16A
- Direct & Independent mounting
- Trip class 10A

Thermal Protection Adjustment	For Use With	For Use With	Unit MRP [₹]
0.11...0.16		LR2K0301	2650
0.16...0.23		LR2K0302	2650
0.23...0.36		LR2K0303	2650
0.36...0.54		LR2K0304	2650
0.54...0.8		LR2K0305	2650
0.8...1.2		LR2K0306	2650
1.2...1.8	LC1K, LP1K, LP4K, LP2K, LC2K	LR2K0307	2650
1.8...2.6		LR2K0308	2650
2.6...3.7		LR2K0310	2650
3.7...5.5		LR2K0312	2650
5.5...8		LR2K0314	2650
8...11.5		LR2K0316	2650
10...14		LR2K0321	2740
12...16		LR2K0322	2740

*Note: Terminal Block for Clip-on Mounting LA7K0064

Thermal Overload Relays - TeSys Deca Series



- Conformance to IEC, UL, CSA
- Range : 0.1A to 104A
- Higher operating temperature
- Tripping class 10A & 20 available
- Direct mounting on contactor is possible upto 95A

Thermal Protection Adjustment Range	For Use With	Reference*	Unit MRP [₹]
LRD Model (Direct Mounting)			
0.1...0.16		LRD01	2705
0.16...0.25		LRD02	2705
0.25...0.4		LRD03	2705
0.4...0.63		LRD04	2705
0.63...1		LRD05 ✓	2705
1...1.6	GV2L03, LE03, LC1D09...LC1D38	LRD06 ✓	2705
1.6...2.5		LRD07 ✓	2705
2.5...4		LRD08 ✓	2705
4...6		LRD10 ✓	2705
5.5...8		LRD12 ✓	2705
7...10		LRD14 ✓	3035
9...13		LRD16 ✓	3035
12...18		LRD21 ✓	3125
16...24	GV2L22, LC1D25...D38	LRD22 ✓	3125
23...32	LC1D25...LC1D38, LC1D32	LRD32 ✓	5025
30...38	LC1D32, LC1D38	LRD35	5025
23...32	LC1D40A...D65a	LRD332	5565
23...32	LC1D80...LC1D95	LRD3353	5565
30...40	LC1D40A...D65a	LRD340	5565
30...40	LC1D80...LC1D95	LRD3355	5565
37...50	LC1D40A...D65a	LRD350 ✓	7630
37...50	LC1D80...LC1D95	LRD3357	9125
48...65	LC1D40A...D65a	LRD365	9790
62...80	LC1D80A	LRD380	10210
48...65	LC1D80...LC1D95	LRD3359	9790
63...80	LC1D80...LC1D95	LRD3363	10625
80...104	LC1D80, LC1D95	LRD3365	13115

Electronic Overload Relay - TeSys Deca Series



- Conformance to IEC, UL, CSA
- Range : 0.1A to 32A
- 5:1 Adjustment range
- High Operating Temperature
- Field selectable tripping class : 5,10, 20 & 30
- Type 1 & Type 2 Co-ordination chart available

Current Range	For Use With	Reference*	Unit MRP [₹]
0.1...0.5		LR9D01	12305
0.4...2.0	LC1D09 - 38A Direct Mounting	LR9D02	12630
1.6...8.0		LR9D08	12630
6.4...32		LR9D32	14135

*Note: For LR9D01 to LR9D32 - Terminal Block for Clip on Mounting LAD7B205.

Electronic Overload Relay - TeSys Giga Series



- Wide range of protection with only 4 references (28A to 630A)
- Switchable protection against ground fault and phase imbalance
- ON status and overload alarm signaling by LED
- Direct mounting of relay with contactors saving in panel space and installation time
- Selectable Trip class from 5E to class 30E to suit different application needs

Thermal Protection Adjustment Range	Reference	Unit MRP [₹]
28...115 A	LR9G115	21930
57...225 A	LR9G225	25585
125...500 A	LR9G500	30090
160...630 A	LR9G630*	on request

*Note:

- For LRD01...LRD35 - Terminal Block for clip-on Mounting LAD7B106
- For LRD33** - Terminal Block for clip-on Mounting LA7D3064 ✓
- For LRD332, LRD340, LRD350 & LRD365 - Connection block for separate mounting LAD96560
- The LRD relays can be used for AC or DC current up to 104A
- For long starting, Class 20 relays are available on request.
- Device for remote tripping and electrical reset is available on request.

For details on non standard references, technical parameters, accessories, compatibility, stockable and non stockable status please contact Customer Care

✓ NORMAL STOCK ITEMS

W.E.F. February 03rd, 2025



- Reduced downtime
- Quick restoration
- Operational Safety
- Power Quality management



Electronic Overcurrent Relays

Digital EOCR

Protection

- Over Current-Definite & Inverse Time
- Under Current
- Phase Loss
- Phase Reversal
- Stall
- Jam
- Imbalance
- Earth Fault*

Diagnostic

- Trip Cause
- Fault History-3 Faults (Cause & Current Value)

Measurement

- Load Current
- Ground Current*
- Running Hours
- Load Current Bar Graph
- i-THD (Current Harmonic Distortion)

Other Features

- Modbus Communication*
- 4-20 mA output for Motor Current*
- Pre-Alarm Contact
- Suitable for 1 Φ & 3 Φ Motors
- Suitable for Low Frequency VFD Operation (10-100Hz)
- Available with Type-2

Analog EOCR

Protection

- Over current
- Phase loss
- Locked rotor

Other Features

- Easy installation, with DIN Rail and Panel Mounting compatibility
- Trip cause display
- Manual/Electrical reset
- Testing Provision through Test Button
- Suitable for 1 Φ & 3 Φ Motors

* In selected models

se.com/in

TeSys Protect EOCR

Digital EOCR





Digital EOCR Without Communication Current Range=0.5A-80A Control Voltage=100VAC-220VAC*					
Description	Display	Bottom Hole		Window Hole	
		Reference	Unit MRP [₹]	Reference	Unit MRP [₹]
Without Ground Fault Protection	Inbuilt	3DM2-WRDUHZ	23270	3DM2-WRDUWZ	23270
	Extended**	FDM2-WRDUHZ	25165	FDM2-WRDUWZ	25165
GF Protection with external CT	Inbuilt	3MZ2-WRAUHZ	23580	3MZ2-WRAUWZ	23580
	Inbuilt	3MZ2-WRCUHZ	23580	3MZ2-WRCUWZ	23580
	Extended**	FMZ2-WRAUHZ	28310	FMZ2-WRAUWZ	28310
	Extended**	FMZ2-WRCUHZ	28310	FMZ2-WRCUWZ	28310
GF Protection with inbuilt CT	Inbuilt	3BZ2-WRAUHZ	34230		
	Inbuilt	3BZ2-WRCUHZ	34230		
	Extended**	FBZ2-WRAUHZ	34780		
	Extended**	FBZ2-WRCUHZ	34780		

Digital EOCR with Modbus Communication Current Range=0.5A-80A Control Voltage=100VAC-220VAC*					
Description	Display	Bottom Hole		Window Hole	
		Reference	Unit MRP [₹]	Reference	Unit MRP [₹]
Without Ground Fault Protection	Inbuilt	I3DM-WRDUHZ	37385	I3DM-WRDUWZ	37385
	Extended**	IFDM-WRDUHZ	37625	IFDM-WRDUWZ	37625
GF Protection with external CT	Inbuilt	I3MZ-WRAUHZ	39755	I3MZ-WRAUWZ	39755
	Inbuilt	I3MZ-WRCUHZ	39755	I3MZ-WRCUWZ	39755
	Extended**	IFMZ-WRAUHZ	45030	IFMZ-WRAUWZ	45030
	Extended**	IFMZ-WRCUHZ	45030	IFMZ-WRCUWZ	45030
GF Protection with inbuilt CT	Inbuilt	I3BZ-WRAUHZ	46065		
	Inbuilt	I3BZ-WRCUHZ	46065		
	Extended**	IFBZ-WRAUHZ	46305		
	Extended**	IFBZ-WRCUHZ	46305		

* Replace **U** with **B** in above reference for Control Voltage =24 V DC
 ** Cable need to be purchased separately
 Contact Customer Care for 4-20mA Output EOCR references & prices

EOCR Accessories

Cable for Extended Display			
Description	Reference	Unit MRP [₹]	
 CABLE-RJ45 1 Meter	CABLE-RJ45-001	2695	
CABLE-RJ45 3 Meter	CABLE-RJ45-003	3520	

ZCT - Ground Fault Protection			
Description	Reference	Unit MRP [₹]	
 ZCT 35 M/M	ZCT-035-Z	7265	
ZCT 80 M/M	ZCT-080-Z	10025	
ZCT 120 M/M	ZCT-120-Z	16490	

External CT for range extension up to 400A				
Current Range	CT Ratio	Reference	Unit MRP [₹]	
 100A	100:5	3CT-H1-100-Z	5925	
150A	150:5	3CT-HH-150-Z	7335	
200A	200:5	3CT-H2-200-Z	7975	
300A	300:5	3CT-H3-300-Z	8520	
400A	400:5	3CT-H4-400-Z	10025	

For details on non standard references, technical parameters, accessories, compatibility, stockable and non stockable status please contact Customer Care

NORMAL STOCK ITEMS

W.E.F. February 03rd, 2025

TeSys Protect

Analog EOCR

EOCR SS

- Without Display



Analog EOCR without Display			
Current Range (A)	Control Voltage	Reference	Unit MRP [₹]
0.5-6	24-240V AC/DC	EOCRSS-05S	7375
0.5-6	380-440V AC	EOCRSS-05W	6040
3-30	24-240V AC/DC	EOCRSS-30S	7375
3-30	380-440V AC	EOCRSS-30W	6040
5-60	24-240V AC/DC	EOCRSS-60S	7375
5-60	380-440V AC	EOCRSS-60W	6040

Note: 2 SPST output contacts
For 60A or higher, combine 05T Type and an external CT (secondary 5A) for use

EOCR SSD

- With Display (Operating Current & Trip Cause)



Analog EOCR with Display			
Current Range (A)	Control Voltage	Reference	Unit MRP [₹]
0.5-6	24-240V AC/DC	EOCRSSD-05S	11030
0.5-6	380-440V AC	EOCRSSD-05W	13585
3-30	24-240V AC/DC	EOCRSSD-30S	11030
3-30	380-440V AC	EOCRSSD-30W	11770
10-60	24-240V AC/DC	EOCRSSD-60S	11030
10-60	380-440V AC	EOCRSSD-60W	11770

Note: 2 SPST output contacts
For 60A or higher, combine 05T Type and an external CT (secondary 5A) for use

For details on non standard references, technical parameters, accessories, compatibility, stockable and non stockable status please contact Customer Care

NORMAL STOCK ITEMS

W.E.F. February 03rd, 2025



TeSys Power

Circuit breakers for motor protection and control

TeSys Deca and TeSys Giga Circuit Breakers provide compact, reliable and efficient solutions:

- Isolation
- Protection against short circuits and overloads
- Conforming to global standards.(IEC/EN/UL/CSA)



se.com/in/TeSys

TeSys Power

Circuit Breakers for Motor Protection

Magnetic Circuit Breaker



- Conformance to IEC 60947 -1,-2,-4
- Magnetic circuit breakers range from 0.1-80 Amps
- High Breaking capacity up to 100kA
- Wide range of accessories

Breaking Capacity at 50Hz		Magnetic Protection Rating (A)	Reference	Unit MRP [₹]
690V	500V			

With Rocker Lever Control (Economy)*

100 kA	100 kA	0.4	GV2LE03	5805
		0.63	GV2LE04	5805
		1	GV2LE05	5805
		1.6	GV2LE06	5805
3 kA	100 kA	2.5	GV2LE07	5805
		4	GV2LE08	5805
3 kA	50 kA	6.3	GV2LE10	5805
	10 kA	10	GV2LE14	5805
3 kA	6 kA	14	GV2LE16	5805
		18	GV2LE20	6740
3 kA	4 kA	25	GV2LE22	6740
		32	GV2LE32	11450

With Rotary Handle Control*

100 kA	100 kA	0.4	GV2L03	6660
		0.63	GV2L04	6660
		1	GV2L05	6660
4 kA	100 kA	1.6	GV2L06	6660
		2.5	GV2L07	6660
		4	GV2L08	6660
		6.3	GV2L10	6660
4 kA	10 kA	10	GV2L14	6660
		14	GV2L16	6660
		18	GV2L20	6660
		25	GV2L22	6660
		32	GV2L32	6660
6 kA	12 kA	40	GV3L40	18610
		50	GV3L50	19045
		65	GV3L65	19460
		73	GV3L73	22005

Breaking Capacity at 415V 50Hz	Motor Power AC-3**		Thermal Protection Adjustment Range	Reference	Unit MRP [₹]
	kW	HP			

With Toggle Control

50 kA	75	101	150	C16N3MA150	On Request
	110	147	220	C25N3MA220	On Request
	160	214	320	C40N31M320	On Request
	200	268	500	C63N31M500	On Request

Thermal Magnetic Circuit Breaker



- Conformance to IEC 60947 -1,-2,-4, conformity to International Standards - UL, CSA, CE
- Thermal magnetic circuit breakers range from 0.1-220 Amps
- High Breaking capacity up to 100kA
- Wide range of accessories
- S-shaped busbar for side-by-side connection with 40 - 65A Contactor

Breaking Capacity at 50Hz		Thermal Protection Adjustment Range	Reference	Unit MRP [₹]
690V	500V			

With Push Button Control (Economy)

100 kA	100 kA	0.1 - 0.16	GV2ME01	6025
		0.16 - 0.25	GV2ME02	6025
		0.25 - 0.40	GV2ME03	6025
		0.40 - 0.63	GV2ME04	6415
		0.63 - 1.0	GV2ME05	6415
3 kA	100 kA	1.0 - 1.6	GV2ME06	6555
		1.6 - 2.5	GV2ME07	6555
3 kA	100 kA	2.5 - 4	GV2ME08	6785
		4 - 6.3	GV2ME10	6785
3 kA	50 kA	4 - 6.3	GV2ME10	6785
	10 kA	6 - 10	GV2ME14	6785
3 kA	6 kA	9 - 14	GV2ME16	7600
		13 - 18	GV2ME20	8180
3 kA	4 kA	17 - 23	GV2ME21	8735
		20 - 25	GV2ME22	8735
		24 - 32	GV2ME32	14150

With Rotary Handle Control

100 kA	100 kA	0.1 - 0.16	GV2P01	5895
		0.16 - 0.25	GV2P02	5895
		0.25 - 0.40	GV2P03	5895
		0.40 - 0.63	GV2P04	6755
		0.63 - 1.0	GV2P05	6755
8 kA	100 kA	1.0 - 1.6	GV2P06	6755
		1.6 - 2.5	GV2P07	6755
6 kA	100 kA	2.5 - 4	GV2P08	6965
	50 kA	4 - 6.3	GV2P10	6965
6 kA	42 kA	6 - 10	GV2P14	7435
		9 - 14	GV2P16	9130
4 kA	10 kA	13 - 18	GV2P20	10535
		17 - 23	GV2P21	10535
		20 - 25	GV2P22	10535
		24 - 32	GV2P32	17760

With Rotary Handle Control

6 kA	12 kA	30...40	GV3P40	20950
		37...50	GV3P50	25975
		48...65	GV3P65	26645
		62...73	GV3P73	27230

With Direct Rotary Handle

10 kA	50 kA	70...150	GV5P150H	49880
		100...220	GV5P220H	58185
		160...320	GV6P320H	74820
		250...500	GV6P500H	103085

It is recommended to check with Customer care team for selection, recommendation, and availability of stockable and non stockable references

✓ NORMAL STOCK ITEMS

W.E.F. February 03rd, 2025

TeSys Power

Circuit Breakers for Motor Protection

Accessories for Motor Circuit Breakers

Description	Reference	Unit MRP [₹]
For GV2		
Front contact NO or NC ⁽¹⁾	GVAE1	1305
Front contact NO + NC	GVAE11 <input checked="" type="checkbox"/>	1595
	GVAE20	1760
Side contact NO + NC	GVAN11 <input checked="" type="checkbox"/>	1925
	GVAN20	1925
Fault signalling contact + 1NO contact ⁽²⁾	GVAD1010 <input checked="" type="checkbox"/>	2505
Fault signalling contact + 1NC contact ⁽²⁾	GVAD1001	2505
Short circuit signalling contact block 1 C/O	GVAM11	2395
Under voltage trip	110 ... 115V 50Hz GVAU115	5165
	220 ... 240V 50Hz GVAU225	4580
	380 ... 400V 50Hz GVAU385	4580
Shunt trip	110 ... 115V 50Hz GVAS115	4580
	220 ... 240V 50Hz GVAS225	4580
	380 ... 400V 50Hz GVAS385	4580
Additive limiter for increasing breaking capacity to 100kA for GV2ME and GV2P.	GV1L3	7385
Connection block - GV2 with contactor LC1-D09..D38	GV2AF3	895
Connection block - LS1 D32 or GV2 with Contactor LC1-K or LP1-K	GV2AF01	970
Empty enclosure for GV2ME - plastic	GV2MP02	4270
	GV2MC02	4690

(1) Choice of NC or NO contact operation depending on which way round the reversible block is mounted.

(2) The GV-AD is always mounted next to the circuit breaker.

Busbars

Connection Pitch	No. of Tapoff Points	Reference	Unit MRP [₹]
For GV2			
45 mm	2	GV2G245	2515
	4	GV2G445	3955
54 mm	2	GV2G254	2290
	3	GV2G354	2570
	4	GV2G454	3220
72 mm	5	GV2G554	3490
	4	GV2G472	3945

Description	Reference	Unit MRP [₹]
Accessories for Busbars		
Terminal block - to supply one or more 3-pole busbar GV2	GV2G05	4945
Protective end covers for unused busbar outlets	GV1G10	870
Terminal block for connection from top	GV1G09	2585

Accessories for Motor Circuit Breakers

Description	Reference	Unit MRP [₹]
For GV2-P/GV2-L		
External operator - IP54, Black	GV2APN01 <input checked="" type="checkbox"/>	4540
External operator - IP54, Yellow/Red	GV2APN02	8455
For GV3P/GV3L		
Auxiliary Contacts		
Front contact: 1 NO (fault) + 1NC (Auxiliary)	GVAED011	1655
Front contact: 1 NO (fault) + 1NO (Auxiliary)	GVAED101	1820
Busbar		
3-pole, 3 tap, 64 mm pitch	GV3G364	2415
S-shape bus bar	GV3S	1810
External Operator		
IP54, Black	GV3APN01	5475

Note: All other accessories are same as of GV2.

Busbars GV3G364 and GV3S are not compatible with GV3*73 and GV3*80.

Description	Operating Voltage	Reference	Unit MRP [₹]
For GV5 and GV6			
Clip-on connector - upto 150 A - 1.5..95 mm ²	-	GV7AC021	1580
Clip-on connector- upto 220 A - 1.5..185 mm ²	-	GV7AC022	2175
Front rotary handle GV7AP GV7R - black handle ⁽²⁾	-	GV7AP01	11445
Terminal shields IP405 ⁽¹⁾	-	GV7AC01	4070

(1) Terminal shields cannot be used together with spreaders.

(2) For mounting direct rotary handle on enclosure door.

This accessory makes it possible to open the door if the device is closed and prevents the device from being closed if the door is open.

It is recommended to check with Customer care team for selection, recommendation, and availability of stockable and non stockable references

NORMAL STOCK ITEMS

W.E.F. February 03rd, 2025

TeSys

Accessories compatibility

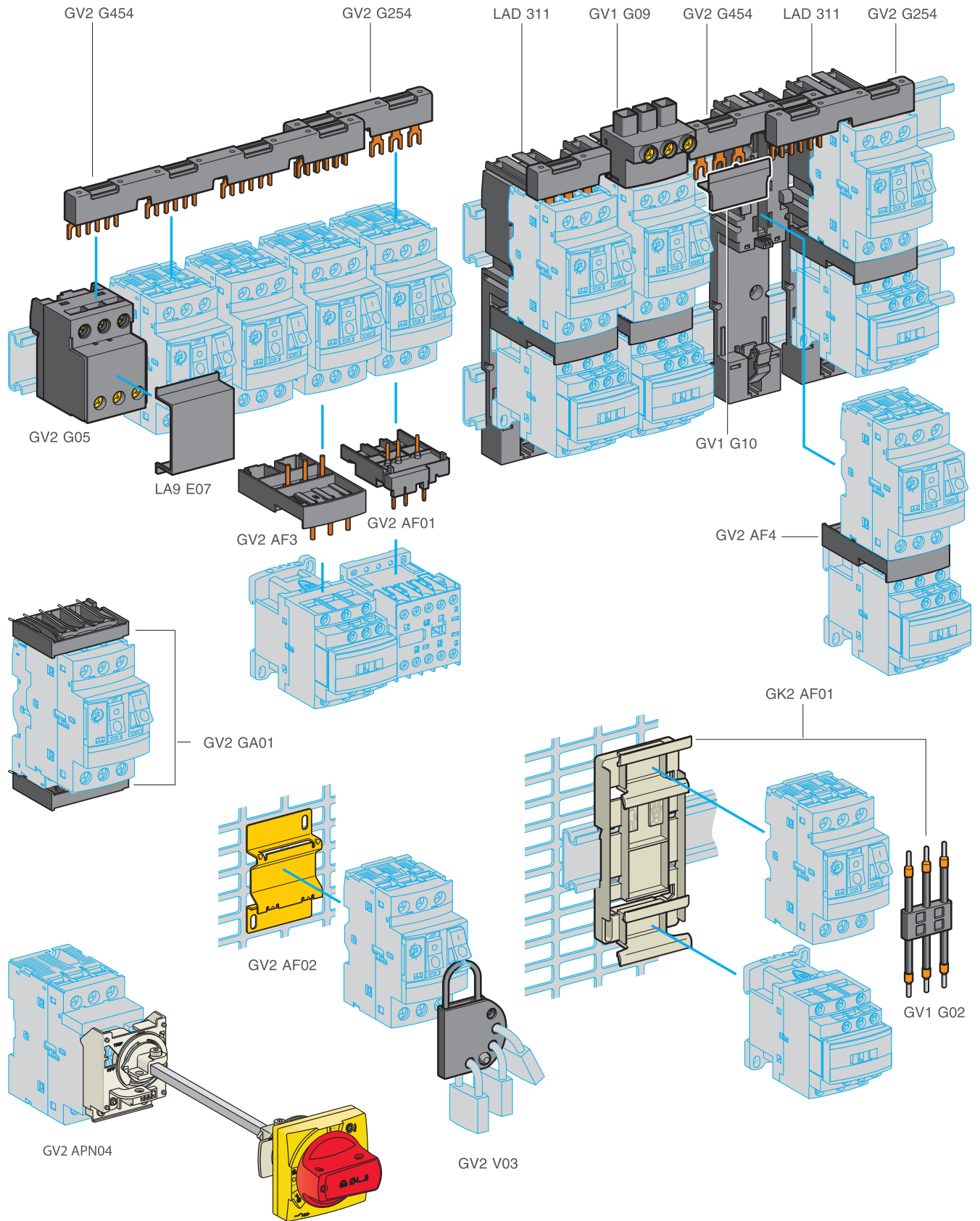

TeSys

Accessories compatibility

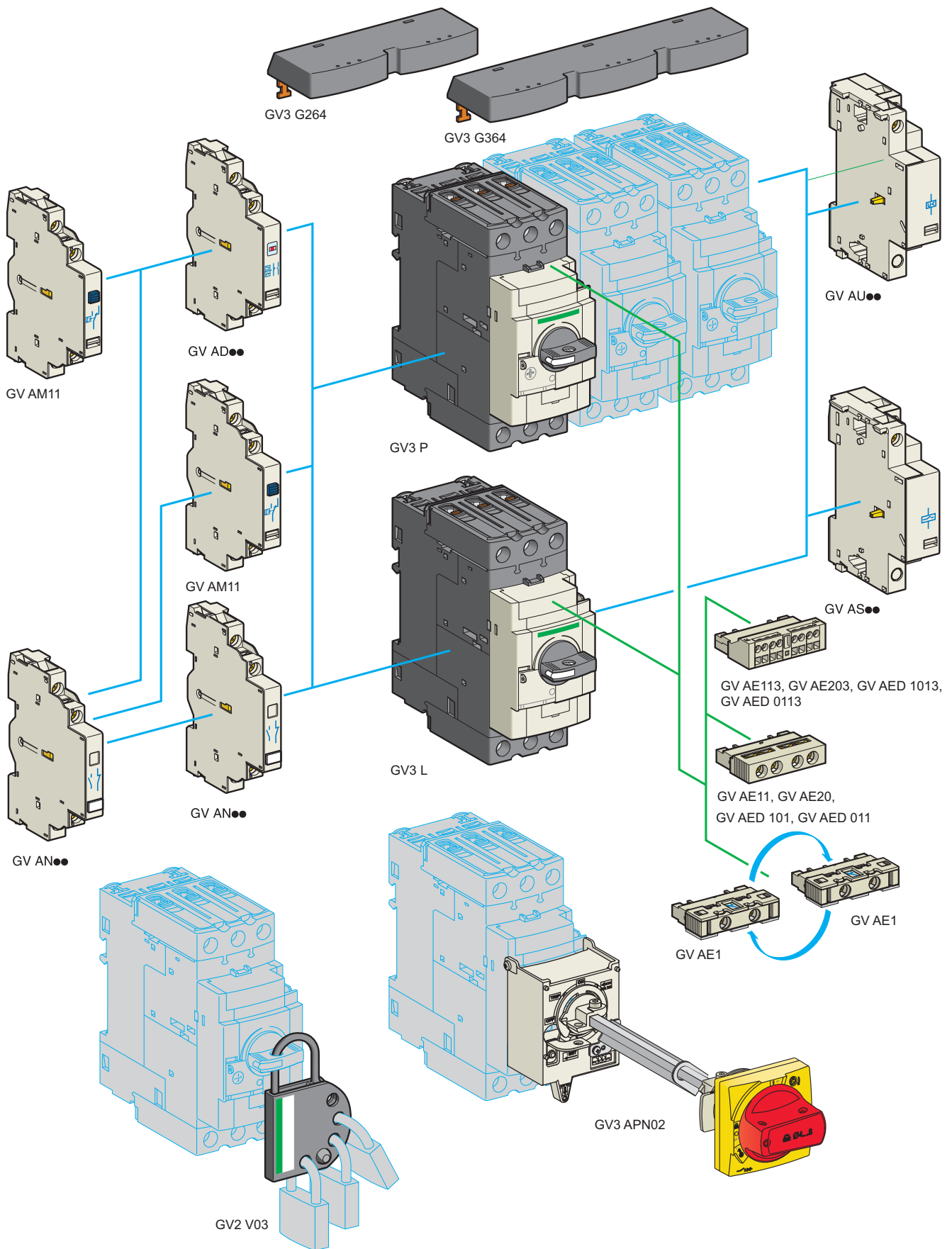

TeSys Control

TeSys Switches

Vario Switch Disconnectors

[Ithe] Conventional Thermal Current**	Poles Description	Rated Operational Power (AC-23)*	Reference	Unit MRP [₹]
Complete Enclosed Switches				
• Range 12 to 175A, IP 65 Sealable and Lockable				
10	3P	4 kW	VCF02GE	4485
16	3P	5.5 kW	VCF01GE	4875
20	3P	7.5 kW	VCF0GE	5930
25	3P	11 kW	VCF1GE	6360
32	3P	15 kW	VCF2GE	7450
50	3P	22 kW	VCF3GE	11525
63	3P	30 kW	VCF4GE	13485

* Rated Power at 415V
** Ith in enclosure

For Switch Type (Amps)	Mounting Arrangement	Ingress	Reference	Unit MRP [₹]
Operators (Padlockable)				
12 - 40	4 Screw Fixing	IP65	KCF1PZ	1265
63 - 80	4 Screw Fixing	IP65	KCF2PZ	1340
125 - 175	4 Screw Fixing	IP40	KCF3PZ	5420

Vario Switch Disconnectors

[Ithe] Conventional Thermal Current**	Poles Description	Reference	Unit MRP [₹]
Complete Switch with Padlockable Operator			
• Suitable for Front Mounting or Base Mounting			
12	3P	VCF02	2815
20	3P	VCF01	3065
25	3P	VCF0	3575
32	3P	VCF1	3745
40	3P	VCF2	4640
63	3P	VCF3	9290
80	3P	VCF4	7870
125	3P	VCF5	18035
175	3P	VCF6	21860
Switch Bodies			
12		V02	1835
20		V01	2115
25		V0	2515
32		V1	3065
40		V2	3745
63		V3	5215
80		V4	6855
125		V5	13910
175		V6	17755

Accessories

Description	For Use with Switch Bodies	Rating in A	Pole Composition	Earth Contact	Auxiliary Contacts	Reference	Unit MRP [₹]
Vario Add-on Modules (1)							
Main Pole Module	V02/VCF02	12	1P	-	-	VZ02	1315
	V01/VCF01	20	1P	-	-	VZ01	1335
	V0/VCF0	25	1P	-	-	VZ0	1425
	V1/VCF1	32	1P	-	-	VZ1	1390
	V2/VCF2	40	1P	-	-	VZ2	1490
	V3/VCF3	63	1P	-	-	VZ3	1935
	V4/VCF4	80	1P	-	-	VZ4	1935
Neutral Pole Module(2)	V02 / VCF02 to V2 / VCF2	-	1N	-	-	VZ11	1600
	V3 / VCF3 to V4 / VCF4	-	1N	-	-	VZ12	2140
	V5 / VCZ5 to V6 / VCZ6	-	1N	-	-	VZ13	4420
Earthing Module	V02 / VCF02 to V2 / VCF20	-	-	-	-	VZ14	1575
	V3 / VCF3 to V4 / VCF4	-	-	1	-	VZ15	1860
	V5 / VCZ5 to V6 / VCZ6	-	-	1	-	VZ16	2890
Auxiliary Contact Block Module	V02/ VCF02 to V6 / VCZ6	-	-	-	1NO + 1NC	VZ7	1645
	V2/ VCF02 to V6 / VCZ6	-	-	-	2NO	VZ20	1645

(1) For mounting option of modules, please refer to the technical catalogue.
(2) With early make and late break contacts

Description	For Use With	Reference	Unit MRP [₹]
Components for Door Interlocking			
Shaft extension - for Mini-VARIO and VARIO - V02..V2	V02...V2	VZ17	1575
	V02...V2	VZ30	1860
Shaft extension - for Mini-VARIO and VARIO - V3 V4 V5 V6	V3, V4, V5, V6	VZ18	1860
	V3, V4, V5, V6	VZ31	2115
Door interlock plate	VZ17 / VZ30	KZ32	540
	VZ18/31	KZ74	925
Input Terminal Protection Shrouds			
Terminal Shrouds	V02 - V2	VZ8	535
	V3 - V4	VZ26	465
	V3 - V4	VZ9	560
	V5 - V6	VZ27	465
	V5 - V6	VZ10	705
	V02 - V6	VZ28	785
	V02 - V6	VZ29	645

For details on non standard references, technical parameters, accessories, compatibility, stockable and non stockable status please contact Customer Care

NORMAL STOCK ITEMS

W.E.F. February 03rd, 2025

TeSys Control

Accessories for Switches

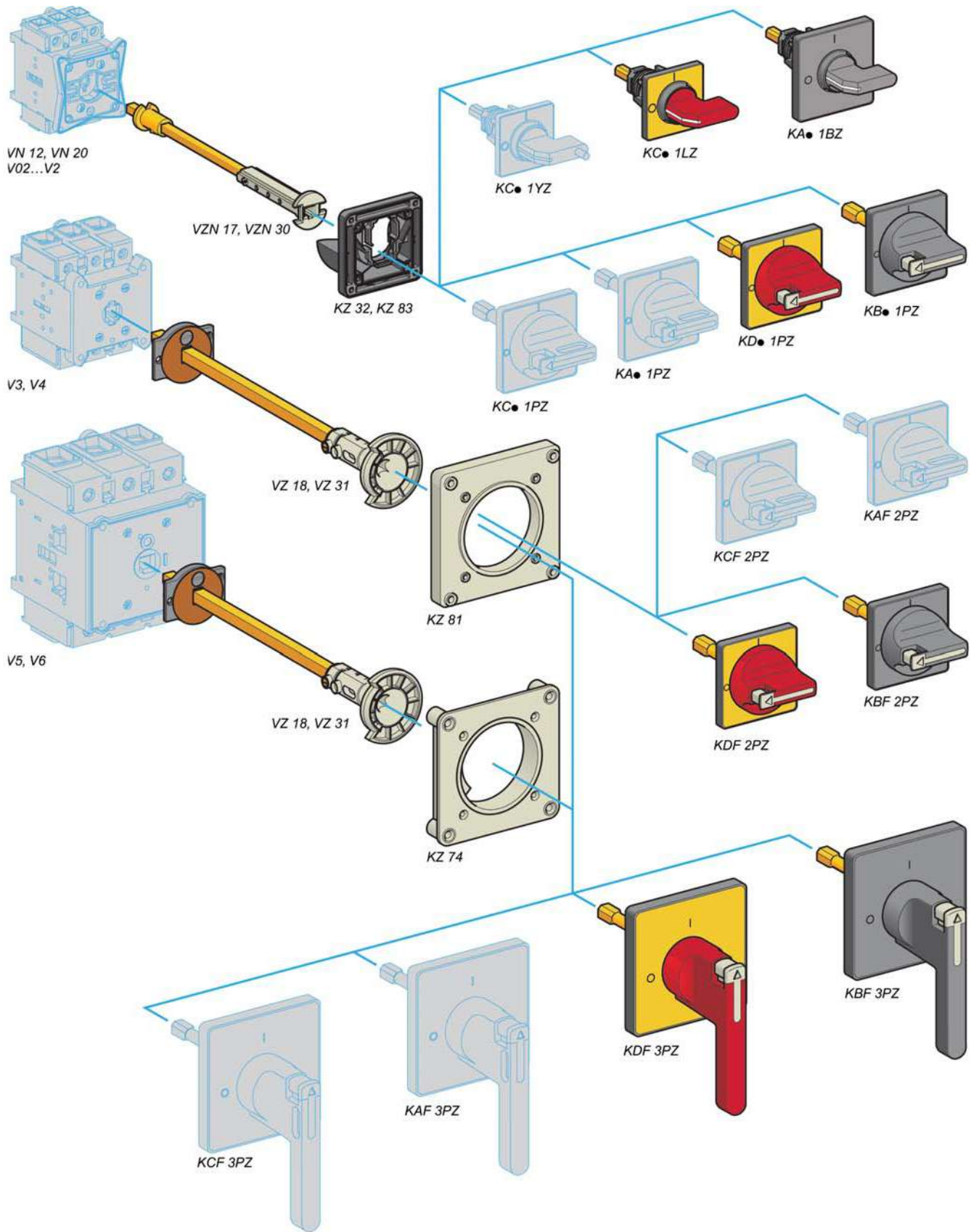



Smarter Load Management with TeSys Island

The Key to Unprecedented Efficiency

Digital Load Manager

TeSys Island - the innovative & digital multifunctional load management solution up to 80A

Industry 4.0

Predictive Maintenance

Cyber Secure



TeSys Active

TeSys Island

• All-in-one Solution for Versatile & Flexible Load Management •

Motor Protection

- Motor Overload
- Over/Under Current
- Jam/Stall
- Long Start
- Rapid Restart Lockout

Upstream Protection

- Phase Loss
- Phase Reversal
- Phase Unbalance
- Ground Current Detection

Analytics

- Health Diagnostic
- Energy Management
- Demand Management

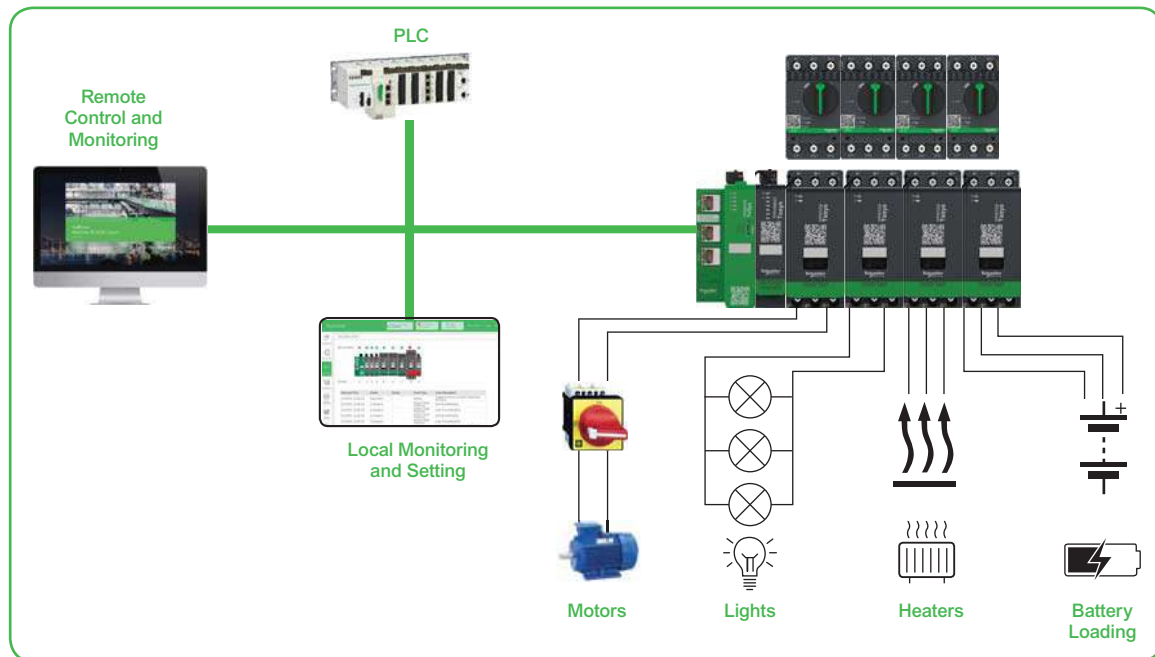

Designation	Product Specification	Commercial Reference
TeSys island components		
Standard Starter	9A (AC-3)	TPRST009
Standard Starter	25A (AC-3)	TPRST025
Standard Starter	38A (AC-3)	TPRST038
Standard Starter	65A (AC-3)	TPRST065
Standard Starter	66A (AC-3) - 80A (AC-1)	TPRST080
SIL Starter	9A (AC-3)	TPRSS009
SIL Starter	25A (AC-3)	TPRSS025
SIL Starter	38A (AC-3)	TPRSS038
SIL Starter	65A (AC-3)	TPRSS065
SIL Starter	66A (AC-3) - 80A (AC-1)	TPRSS080
Power interface module	9A (AC-3)	TPRPM009
Power interface module	38A (AC-3)	TPRPM038
Power interface module	80A (AC-3)	TPRPM080
Voltage interface module		TPRVM001
SIL interface module		TPRSM001
Digital I/O module	(4 input - 2 output)	TPRDG4X2
Analog I/O module	(2 input - 1 output)	TPRAN2X1
Bus Coupler	EtherNet/IP - Modbus TCP	TPRBCEIP
Bus Coupler	PROFINET	TPRBCPFN
Bus Coupler	PROFIBUS	TPRBCPFIB
Assembly and Wiring Kits		
Kit for reversing starter application	for 9, 25, 38A (size 1 and 2) starters	LAD9R1
Kit for reversing starter application	for 65, 80A (size 3) starters	LAD9R3
Jumper bar 3-pole for Star Delta application	for 9, 25, 38A (size 1 and 2) starters	LAD9P3
Kit for reversing starter application	for 65, 80 A (size 3) starters, a hazard sticker is provided	LAD9SD3S

*Architecture shown above is only for graphical representation

TeSys Control

Ultra motor starters

Introduction

From traditional solution



Ultra motor starter- All in one block for advance protection

Motor circuit breaker:
GV2L



Magnetic protection
> short-circuit protection

Contactor:
LC1D



Control
> Start/Stop

Status monitoring
> signaling
> alarm monitoring

Protection relay:
LRD



Thermal protection
> overload



Ultra motor starter
> All basic or advanced protection and control functions in one block

and more...

- > Overload indication and alarm
- > Status report, remote control via communication bus

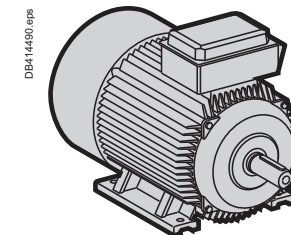

Ultra motor starters
can be used in
80 %
of motor protection and control applications.

TeSys Control

Ultra motor starters



- Total Coordinated Starter – 3 functions in a single device
- Compact Starter, DOL / RDOL upto 18.5kW (38A, AC-3) in 45mm width
- Direct connectivity to Modbus / Profibus / CANopen / DeviceNet
- Higher switching life - 15Million operations, 2Million AC-43 electrical life
- Breaking capacity upto 130kA



Power Base

For assembling components, ON/OFF operation and resetting.
 > 3 power bases:
 upto 12A and upto 38A
 > Direct starter and reversing starter models.

Control Unit

Performs all the electrical protection functions to cover main applications from 0 to 38A.

Some of these also provide advanced measurement, alarm and display functions.

4 simple function modules

Thermal overload alarm Indication of motor load
 Thermal overload signalling and manual reset
 Thermal overloaded signalling and automatic or remote reset.

4 communication modules

Profibus DP
 CANopen
 DeviceNet
 Modbus.

40%

“TeSys solutions allow us to reduce the size of our enclosure” says a panel builder from the water treatment sector

60%

“Late customization means that we can build 60% of the panels, even though the project design has not yet been completed” says an engineer in a food processing industry

Quick Selection

Select 1	+	Select 1	Optional	or	Optional	or	Optional											
Base Power Unit Non-Reversing LUB 120 0.. 12A with terminal 12 0.. 12A no terminal 120* 0.. 32A with terminal 32 0.. 32A no terminal 320* 0.. 38A with terminal 38 0.. 38A no terminal 380* Reversing LU2B 120 BL 0.. 12A with terminal 12 0.. 12A no terminal 120* 0.. 32A with terminal 32 0.. 32A no terminal 320* 0.. 38A with terminal 38 0.. 38A no terminal 380* 24 V DC BL 24 V AC B 48...72 VAC or 48 VDC ES 110...240 VAC/DC FU <small>*prewired cables to be ordered separately</small>		Control Unit LUC B X6 BL Class 10, 3Ph B Class 10, 1Ph C Class 20, 3Ph D 0.15 to 0.6 A X6 0.35 to 1.4 A 1X 1.25 to 5 A 05 3 to 12 A 12 4.5 to 18 A 18 8 to 38 A 38 24V DC BL 24VAC B 48...72 VAC/48 VDC ES 110...240VAC/DC FU	Communication Module* LULC 033 Modbus Serial 033 Profibus DP 07 CANopen 08 DeviceNet 09 Prewired Cables <table border="1"> <thead> <tr> <th>Description</th> <th>Reference</th> </tr> </thead> <tbody> <tr> <td>Prewired cable for non-reversing power base</td> <td>LU9BN11C or LU9BN11L</td> </tr> <tr> <td>Prewired cable for reversing power base</td> <td>LU9MRC or LU9MRL</td> </tr> </tbody> </table>	Description	Reference	Prewired cable for non-reversing power base	LU9BN11C or LU9BN11L	Prewired cable for reversing power base	LU9MRC or LU9MRL	Function Module LUF DH11 Fault diff. with manual reset DH11 Fault diff. with auto reset DA10 Thermal overload pre-alarm W10 Motor load indication (4-20mA) V2	Auxiliary Contacts LUFN 11 Contactor auxiliary contacts 1NO + 1NC 11 2NC 02 2NO 20 Side contacts 2NO LUA8E20 Power auxiliary contacts (trip status) LUA1C 20 1NO + 1NC 11 2NO 20	Accessories <table border="1"> <thead> <tr> <th>Description</th> <th>Reference</th> </tr> </thead> <tbody> <tr> <td>Line spacer for UL508 Type E</td> <td>LU9SPO</td> </tr> <tr> <td>Current limiter 130kA@460V</td> <td>LUALB1</td> </tr> </tbody> </table>	Description	Reference	Line spacer for UL508 Type E	LU9SPO	Current limiter 130kA@460V	LUALB1
Description	Reference																	
Prewired cable for non-reversing power base	LU9BN11C or LU9BN11L																	
Prewired cable for reversing power base	LU9MRC or LU9MRL																	
Description	Reference																	
Line spacer for UL508 Type E	LU9SPO																	
Current limiter 130kA@460V	LUALB1																	

*Suitable with 24V DC starter variant only

Note: For prices please contact Customer Care

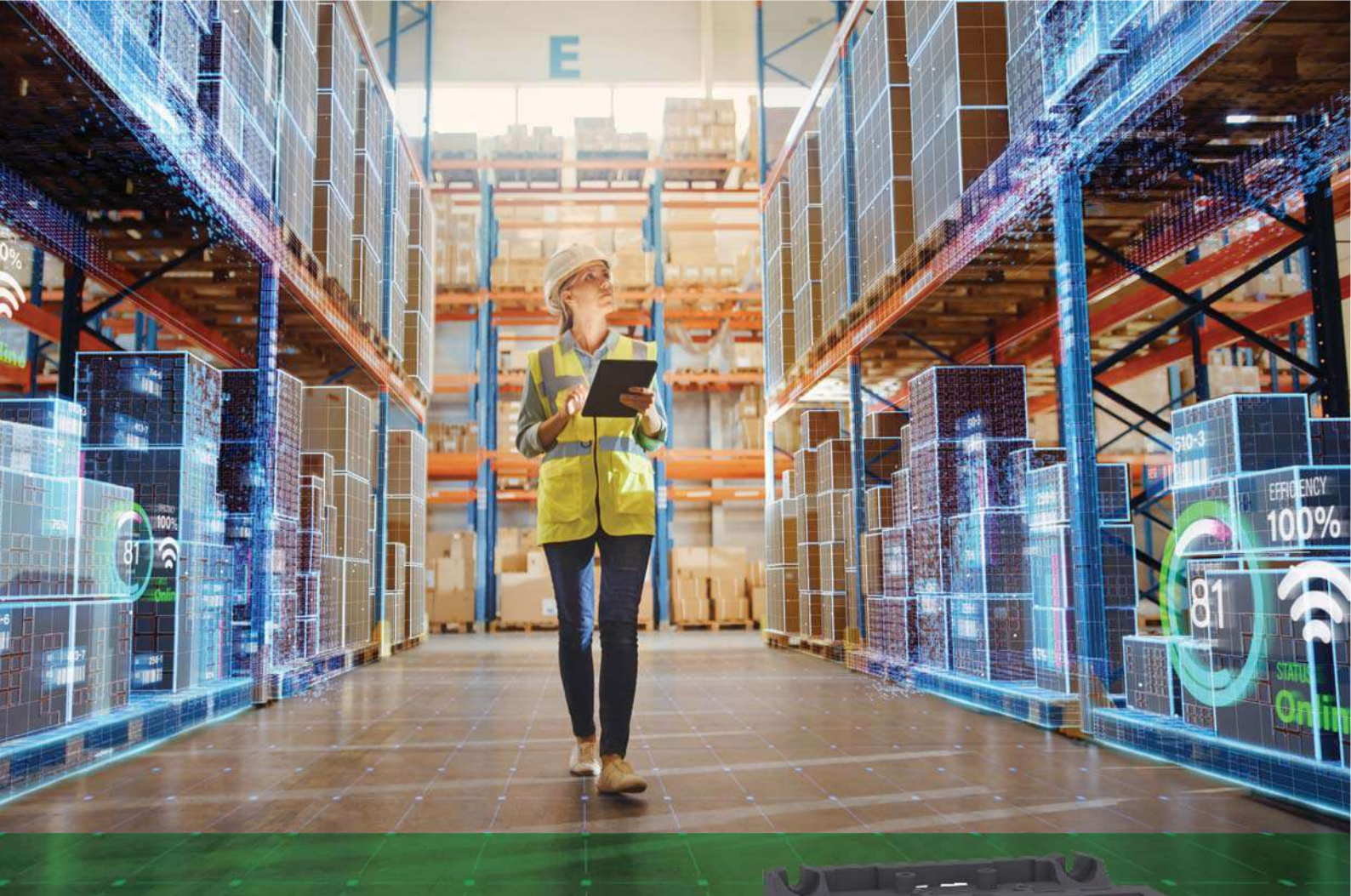

Wherever productivity is a concern, intelligence to Motor Control is the solution

Give six sense to your conventional motor control center (MCC) with the Intelligent Motor Control Center (iMCC) - through our intelligent relay, TeSys T, which offer enhanced protections and built-in intelligent features!

Tesys T Motor Management Systems

TeSys T Controller:

Intelligent motor controller for 1P/3P Motors with built in CT up to 100Amps with accurate monitoring and protection functions, 6DI, 4DO, 1CBCT input, 1 Temperature probe

Protection Functions:

- Thermal overload
- Phase imbalance and phase overloads
- Temperature monitoring via probes
- Phase reversal
- Ground fault detection
- Long start and Jam protection
- Load shedding
- Load fluctuations
- power factor monitoring

Monitoring Functions:

- Phase and average current
- Line to Line and average voltage
- Motor temperature, ground current
- Active and Reactive Energy
- Frequency & Power Factor
- Detailed Fault history
- Fault counts
- motor statistics

Control Functions:

- Local / Remote / HMI control
- Predefined programs for DOL, RDOL, Star-delta, two-speed starters

Communication:



Quick Selection

TeSys T Controller

Reference	
LTM R	100 E BD
Current Range	0.4 - 8 A 08
	1.35 - 27 A 27
	5 - 100 A 100
Network Protocol	Ethernet IP / Modbus TCP/IP E
	Modbus M
	Profibus DP P
Control Voltage	24 V DC BD
	110-240V AC FM



TeSys T
Full and Flexible
Intelligent Motor
Management System

TeSys T Accessories

TeSys T Expansion Module^{1,2}

Control Voltage	Reference
24 V DC	LTM EV40BD
110V AC	LTM EV40FM

¹ Required for Voltage & Power measurement
² 4 digital inputs

Connector for Expansion

Length (m)	Reference
0.04	LTMCC004 ³

³ Sold in lots of 6

Ground Fault CT's

Primary [A]	Internal Ø "d" [mm]	Reference
65	30	50437
85	50	50438
160	80	50439
250	120	50440
400	200	50441
630	300	50442

Description	Composition	Reference
Programming software SoMove	1 Program for each PC	On request
PC connecting cable	USB to RS485 Converter	TCSMCNAM3M002P

Operator Control Display

Description	Reference
Operator Control Display with configuration backup	LTM CUF

Controller to Display Cable

Length (m)	Reference
1.0	LTM9CU10
3.0	LTM9CU30

Current Transformers⁴

Primary [A]	Secondary [A]	Reference
100	1	LT6 CT1001
200	1	LT6 CT2001
400	1	LT6 CT4001
800	1	LT6 CT8001

Note: For prices please contact Customer Care



Coming Soon

TeSys Tera

Experience the enhanced intelligence of your Motor Management System with our new and advanced TeSys Tera.



Sustainable

Versatile

Efficient

Modular



All-in-one
Motor protection



On-device programming

With direct-to-device connection, setup and configuration has **never been easier**



Real-time monitoring

Locally or in the cloud, giving open, **cross-platform connectivity**



Enhanced efficiency

through advanced features such as **Load Shedding** and an **Auto Restart** function



Flexible

with pre-configured designs and **plug-and-play**



Connectivity

via common **communication protocols**



More data, less downtime

Detailed diagnostics enables **predictive maintenance** to help you stay online more of the time

Life Is 

Schneider
 Electric

Schneider Electric India Pvt. Ltd.

Corporate Office: 9th Floor, DLF Building No. 10, Tower C, DLF Cyber City, Phase II, Gurugram - 122002, Haryana
Tel: 0124 3940400, www.se.com/in

Ahmedabad
Schneider Electric India (P) Ltd.
1506-1507, 15th Floor Shaph-5
Opp.Karnavati Club, SG Highway,
Ahmedabad, Gujarat - 380015
Tel.: 079-66826701

Coimbatore
Schneider Electric India Pvt. Ltd.
Mikro Grafeio Services Pvt Ltd.,
Elysium Tower, #21, A.T.T
Colony, Near Honda Office,
Coimbatore, Tamil Nadu - 641018

Lucknow
Schneider Electric India (P) Ltd.
Summit, Plot No. TCG 3/3
6th Floor, 604A/B/C, Vibhuti Khand
Gomti Nagar, Lucknow
Uttar Pradesh - 226010
Tel.: 0522-3500334

Nashik
Schneider Electric India (P) Ltd.
401, 4th Floor, Rishi Raj Towers
Jehan Circle, Gangapur Road
Nashik - 422013
Tel.: 0253-2344333

Bengaluru
Schneider Electric India (P) Ltd.
No. 3/1, JP Techno Park
Mezzanine Floor, Millers Tank Bund
Road, Vasanth Nagar
Bengaluru - 560052
Tel.: 080-71481351

Hyderabad
Schneider Electric Pvt. Ltd.
4B-4th Floor, Gumidelli Towers,
Prakash Nagar, Begumpet,
Hyderabad - 500016

Ludhiana
Schneider Electric India (P) Ltd.
SCO 23, 2nd Floor,
Chandigarh Road, Sector 32
Ludhiana, Punjab -141010
Tel.: 0161- 5203011

New Delhi
Schneider Electric India (P) Ltd.
C-56, Mayapuri Industrial Area, Phase-2
New Delhi - 110064
Tel.: 011-61317400

Bhubaneswar
Schneider Electric India (P) Ltd.
Workloop Co-Working in the property
Office No. 316, Esplanade One Mall
Rasulgarh, Bhubaneswar - 751010

Indore
Schneider Electric India (P) Ltd.
219, Dhan Trident Building
Vijay Nagar, A.B.Road
Indore - 452001

Mohali
Schneider Electric India (P) Ltd.
2nd Floor, Tower-A
Bestech Business Tower
Mega Information & Technology Park
Industrial Plot No.1, Phase IX
(Expansion), Mohali - 160059
Tel.: 0172-7198200

Pune
Schneider Electric India (P) Ltd.
Amar Caliber, CTS No 911, BMCC Road,
OFF F.C. Road, Deccan Gymkhana,
Shivaji Nagar, Pune - 411007
Tel.: 020-67492500

Chennai
Schneider Electric India (P) Ltd.
No: 29, 2nd Floor,
Bannari Amman Towers, B-Block
Dr. Radhakrishnan Road, Mylapore
Chennai - 600 004
Tel.:044-71912000

Jaipur
Schneider Electric India (P) Ltd.
Jaipur Business Centre 309
3rd Floor, Sangam Tower 190
Church Road, Jaipur - 302001
Tel.: 0141-2374810

Mumbai
Schneider Electric India Pvt. Ltd.
L&T Business Park, Tower B,
7th Floor, TC-II, Gate No.5,
Saki Vihar Road, Powai,
Mumbai - 400072

Vadodara
Schneider Electric India (P) Ltd.
Notus IT Park, 10th Floor, Block-D
Sarabhai Campus, Vadiwadi
Vadodara, Gujarat - 390017

Cochin
Schneider Electric India (P) Ltd.
Alapatt Properties Private Limited
(Trade Name: Centre A)
Main Door Number: 66/4971
(Old Door Number: 40/6584-H)
7th Floor Alapatt Heritage Building
MG Road Kochi - 682035

Kolkata
Schneider Electric (I) Pvt. Ltd.
BN3, Salt Lake, Sector V,
Kolkata - 700091

Nagpur
Schneider Electric India (P) Ltd.
6, Vasant Vihar Complex
W.H.C Road, Shankar Nagar
Nagpur - 440010
Tel.: 0712-2558581

Vishakhapatnam
Schneider Electric India (P) Ltd.
D.N.10-1-43, 1st Floor
Ratnam's Business Centre,
Siripuram Fort, C.B.M.Compound
Visakhapatnam - 530016
Tel.: 0891-6675500

Customer Care Centre

Monday-Saturday, 9 a.m. to 8 p.m.
Toll-free numbers: 1800 419 4272, 1800 103 0011
Email: customercare.in@schneider-electric.com

For more information, visit our website at: www.se.com/in

- All Prices are in Indian Rupees
- Prices are subject to change without prior notice
- Product evolution is a continuous process and Schneider Electric reserves the right to modify/withdraw any product at any time without prior notice
- Prices charged will be as prevailing on the date of dispatch
- Invoice Amount = (MRP – less Applicable discount) + Applicable GST %
- Tax incidence on invoices is basis applicable GST rates
- Invoice amount not to exceed MRP
- Product pictures shown are for illustration purpose only; actual product may vary
- Kindly refer product datasheet for detailed specification

Distributor